

JCY-1900

VOYAGE DATA RECORDER

Conforming to IMO MSC.333(90)/MSC.494(104)

**INSTRUCTION
MANUAL**

■ NOTICE

- Reproduction of all or part of this manual without permission is prohibited.
- The contents of this manual are subject to change without notice.

Copyright© Japan Radio Co., Ltd. 2014 All rights reserved.

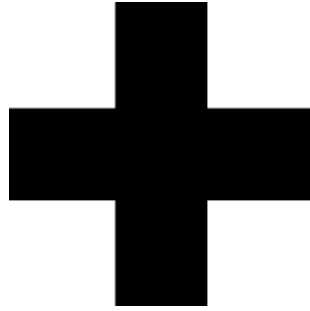

Cautions for High Voltage

High voltages, ranging from several hundreds to tens of thousands of volts, are used in electronic apparatus, such as radio and radar instruments. These voltages are totally harmless in most operations. However, touching a component inside the unit is very dangerous. (Any person other than authorized service engineers should not maintain, inspect, or adjust the unit.)

High voltages on the order of tens of thousands of volts are most likely to cause instant deaths from electrical shocks. At times, even voltages on the order of several hundred volts could lead to electrocution. To defend against electrical shock hazards, don't put your hand into the inside of apparatus. When you put in a hand unavoidably in case of urgent, it is strongly suggested to turn off the power switch and allow the capacitors, etc. to discharge with a wire having its one end positively grounded to remove residual charges. Before you put your hand into the inside of apparatus, make sure that internal parts are no longer charged. Extra protection is ensured by wearing dry cotton gloves at this time. Another important precaution to observe is to keep one hand in your pocket at a time, instead of using both hands at the same time.

It is also important to select a secure footing to work on, as the secondary effects of electrical shock hazards can be more serious. In the event of electrical shocks, disinfect the burnt site completely and obtain medical care immediately.

Precautions for Rescue of Victim of Electric Shock

When a victim of electric shock is found, turn off the power source and ground the circuit immediately. If this is impossible, move the victim away from the unit as quick as possible without touching him or her with bare hands. He or she can safely be moved if an insulating material such as dry wood plate or cloth is used.

Breathing may stop if current flows through the respiration center of brain due to electric shock. If the electric shock is not large, breathing can be restored by artificial respiration. A victim of electric shock looks pale and his or her pulse may become very weak or stop, resulting in unconsciousness and rigidity at worst. It is necessary to perform first aid immediately.

Method of First-Aid Treatment

Precautions for First-Aid Treatments

Whenever a person is struck by an electrical shock, give the patient artificial respiration immediately on the spot, unless it is absolutely necessary to move the patient for safety's sake. Once started, artificial respiration should be continued rhythmically.

- (1) Refrain from touching the patient carelessly as a result of the accident; the first-aiders could suffer from electrical shocks by himself or herself.
- (2) Turn off the power calmly and certainly, then move the patient apart from the cable gently.
- (3) Call or send for a physician or ambulance immediately, or ask someone to call doctor.
- (4) Lay the patient on the back, loosening the necktie, clothes, belts and so on.
- (5)
 - (a) Feel the patient's pulse.
 - (b) Check the heartbeat by bringing your ear close to the patient's heart.
 - (c) Check for respiration by bringing your face or the back of your hand to the patient's face.
 - (d) Check the size of patient's pupils.
- (6) Opening the patient's mouth, remove artificial teeth, cigarettes, chewing gum, etc. if any. With the patient's mouth open, stretch the tongue and insert a towel or the like into the mouth to prevent the tongue from being withdrawn into the throat. (If the patient clenches the teeth so tight that the mouth won't open, use a screwdriver or the like to force the mouth open and then insert a towel or the like into the mouth.)
- (7) Wipe off the mouth to prevent foaming mucus and saliva from accumulating.

Treatment to Give When the Patient Has a Pulse Beating but Has Ceased to Breathe

* Performing mouth-to-mouth artificial respiration (see Figure 1).

- (1) Bend the patient's face backward until it is directed to look back. (A pillow may be placed under the neck.)
- (2) Pull up the lower jaw to open up the airway. (To spread the airway.)
- (3) Pinching the patient's nose, breathe deeply and blow your breath into the patient's mouth strongly, with care to close it completely. Then, move your mouth away and take a deep breath, and blow into his or her mouth. Repeat blowing at 10 to 15 times a minute (always with the patient's nostrils closed).
- (4) Continue artificial respiration until natural respiration is restored.
- (5) If the patient's mouth won't open easily, insert a pipe, such as one made of rubber or vinyl, into either nostril. Then, take a deep breath and blow into the nostril through the pipe, with the other nostril and the mouth completely closed.
- (6) The patient may stand up abruptly upon recovering consciousness. Keep the patient lying calmly, giving him or her coffee, tea or any other hot drink (but not alcoholic drink) to keep him or her warm.

Mouth-to-mouth artificial respiration with the patient's head lifted:

[1]



- (1) Lift the back part of the patient's head. Support the forehead with one of your hand and the neck with the other hand.

→ [1]

Many patients will have their airways opened by lifting their head in this way to ease mouth-to-mouth artificial respiration.

[2]

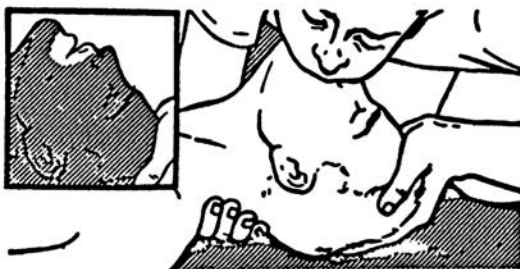

- (2) Closing the patient's mouth with your mouth, press your cheek against the patient's nose.

→ [2]

Alternatively, hold the patient's nose with your finger to prevent air leak

→ [3]

[3]



- (3) Blowing air into the patient's lungs. Blow air into the patient's lungs until chest is seen to rise. The first 10 breaths must be blown as fast as possible.

Figure 1 Mouth-to-mouth artificial respiration

Flow of Cardiopulmonary Resuscitation (CPR) Using the AED (Automated External Defibrillator)

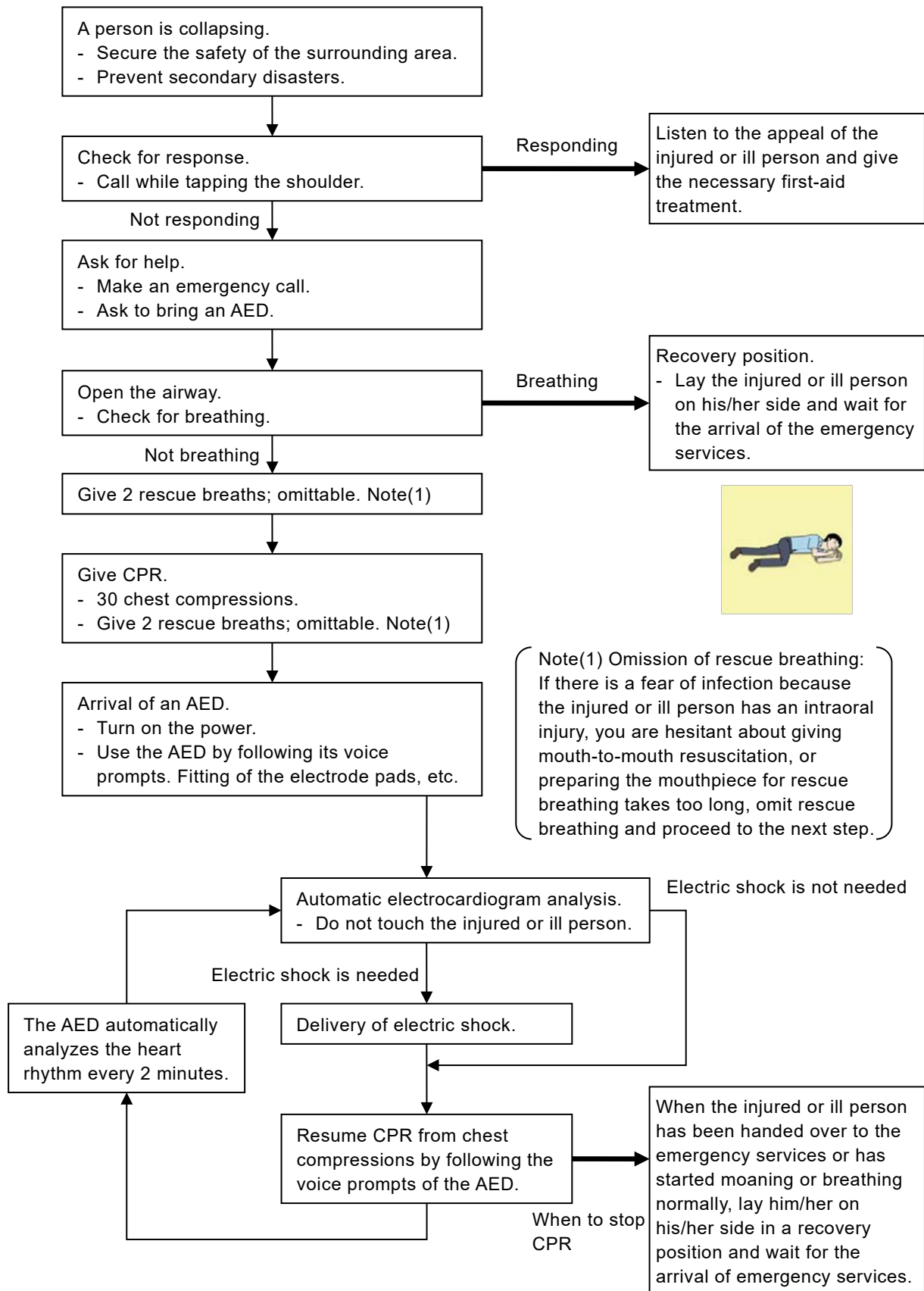

Procedure for Cardiopulmonary Resuscitation (CPR) Using the AED (Automated External Defibrillator)

1. Check the scene for safety to prevent secondary disasters

- a) Do not touch the injured or ill person in panic when an accident has occurred. (Doing so may cause electric shock to the first-aiders.)
- b) Do not panic and be sure to turn off the power. Then, gently move the injured or ill person to a safe place away from the electrical circuit.

2. Check for responsiveness

- a) Tap the shoulder of the injured or ill and shout in the ear saying, "Are you OK?"
- b) If the person opens his/her eyes or there is some response or gesture, determine it as "responding". But, if there is no response or gesture, determine it as "not responding".



3. If responding

- a) Give first-aid treatment.

4. If not responding

- a) Ask for help loudly. Ask somebody to make an emergency call and bring an AED.
 - **Somebody has collapsed. Please help.**
 - **Please call an ambulance.**
 - **Please bring an ambulance AED.**
 - If there is nobody to help, call an ambulance yourself.



5. Open the airway

- a) Touch the forehead with one hand.
- b) Lift the chin with the two fingers of the middle finger and forefinger of the other hand.
- c) Push down on the forehead as you lift the jaw to bring the chin forward to open the airway. If neck injury is suspected, open the airway by lifting the lower jaw.

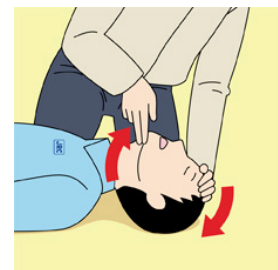

6. Check for breathing

- a) After opening the airway, check quickly for breathing for no more than 10 seconds. Put your cheek down by the mouth and nose area of the injured or ill person, look at his/her chest and abdomen, and check the following three points.
- Look to see if the chest and abdomen are rising and falling.
 - Listen for breathing.
 - Feel for breath against your cheek.
- b) If the injured or ill person is breathing, place him/her in the recovery position and wait for the arrival of the emergency services.
- Position the injured or ill person on his/her side, maintain a clear and open airway by pushing the head backward while positioning their mouth downward. To maintain proper blood circulation, roll him/her gently to position them in the recovery position in the opposite direction every 30 minutes.

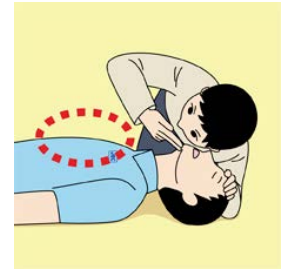

7. Give 2 rescue breaths (omittable)

- a) If opening the airway does not cause the injured or ill person to begin to breathe normally, give rescue breaths.
- b) If there is a fear of infection because the injured or ill person has an intraoral injury, you are hesitant about giving mouth-to-mouth resuscitation, or getting and preparing the mouthpiece for rescue breathing takes too long, omit rescue breathing and perform chest compressions.
- c) When performing rescue breathing, it is recommended to use a mouthpiece for rescue breathing and other protective devices to prevent infections.
- d) While maintaining an open airway, pinch the person's nose shut with your thumb and forefinger of the hand used to push down the forehead.
- e) Open your mouth widely to completely cover the mouth of the injured or ill person so that no air will escape. Give rescue breathing **twice in about 1 second** and check if the chest rises.



8. Cardiopulmonary resuscitation (CPR) (combination of chest compressions and rescue breaths)

a) Position of chest compressions

Position the heel of one hand in the center of the chest, approximately between the nipples, and place your other hand on top of the one that is in position.

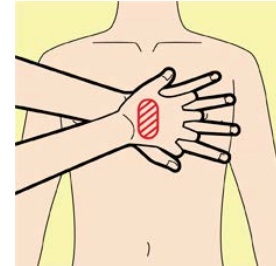
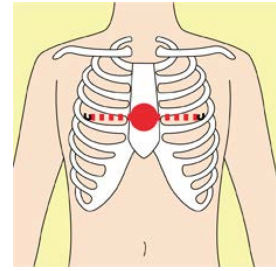

b) Perform chest compressions

- Perform uninterrupted chest compressions of **30** at the rate of **about 100 times per minute**. While locking your elbows positioning yourself vertically above your hands.
- With each compression, depress the chest wall to a depth of approximately **4 to 5 cm**.

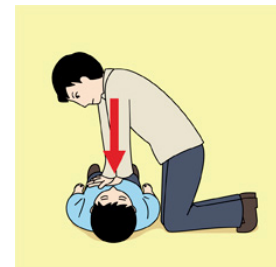
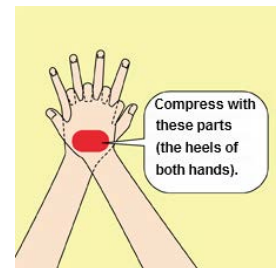

c) Combination of **30 chest compressions** and **2 rescue breaths**

- After performing **30 chest compressions**, give **2 rescue breaths**. If rescue breathing is omitted, perform only chest compressions.
- Continuously perform the combination of **30 chest compressions** and **2 rescue breaths** without interruption.
- If there are two or more first-aiders, alternate with each other approximately **every two minutes** (five cycles of compressions and ventilations at a ratio of 30:2) without interruption.

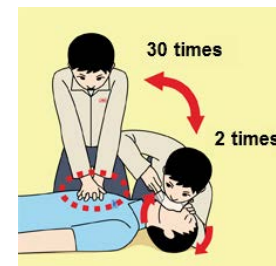

9. When to stop cardiopulmonary resuscitation (CPR)

- a) When the injured or ill person has been handed over to the emergency services.
- b) When the injured or ill person has started moaning or breathing normally, lay him/her on his/her side in a recovery position and wait for the arrival of emergency services.

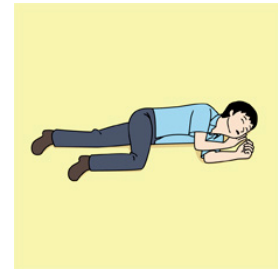

10. Arrival and preparation of an AED

- a) Place the AED at an easy-to-use position. If there are multiple first-aiders, continue CPR until the AED becomes ready.
- b) Turn on the power to the AED unit. Depending on the model of the AED, you may have to push the power on button, or the AED automatically turns on when you open the cover.
- c) Follow the voice prompts of the AED.



11. Attach the electrode pads to the injured or ill person's bare chest

- a) Remove all clothing from the chest, abdomen, and arms (male or female).
- b) Open the package of electrode pads, peel the pads off and securely place them on the chest of the injured or ill person, with the adhesive side facing the chest. If the pads are not securely attached to the chest, the AED may not function. Paste the pads exactly at the positions indicated on the pads, if the chest is wet with water, wipe dry with a dry towel and the like, and then paste the pads. If there is a pacemaker or implantable cardioverter defibrillator (ICD), paste the pads at least 3 cm away from them. If a medical patch or plaster is present, peel it off and then paste the pads. If the injured or ill person's chest hair is thick, paste the pads on the chest hair once, peel them off to remove the chest hair, and then paste new pads.
- c) Some AED models require to connect a connector by following voice prompts.
- d) The electrode pads for small children should not be used for children over the age of 8 and for adults.

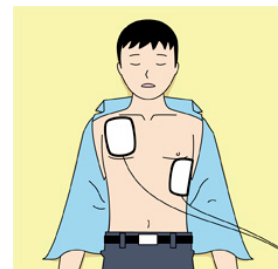
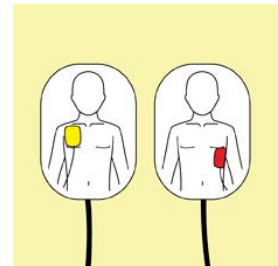

12. Electrocardiogram analysis

- a) The AED automatically analyzes electrocardiograms. Follow the voice prompts of the AED and ensure that nobody is touching the injured or ill person while you are operating the AED.
- b) On some AED models, you may need to push a button to analyze the heart rhythm.



13. Electric shock (defibrillation)

- a) If the AED determines that electric shock is needed, the voice prompt saying, “Shock is needed” is issued and charging starts automatically.
- b) When charging is completed, the voice prompt saying, “Push the shock button” is issued and the shock button flashes.
- c) The first-aider must get away from the injured or ill person, make sure that no one is touching him/her, and then press the shock button.
- d) When electric shock is delivered, the body of the injured or ill person may jerk.

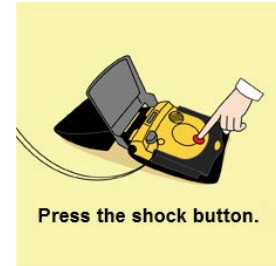

14. Resume cardiopulmonary resuscitation (CPR)

Resume CPR consisting of 30 chest compressions and 2 rescue breaths by following the voice prompts of the AED.

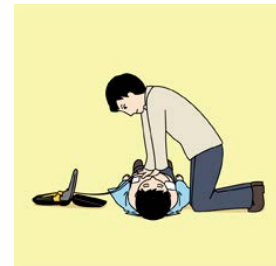

15. Automatic electrocardiogram analysis

- a) When 2 minutes have elapsed since you resumed cardiopulmonary resuscitation (CPR), the AED automatically analyzes the electrocardiogram.
- b) If you suspended CPR by following voice prompts and AED voice prompt informs you that shock is needed, give electric shock again by following the voice prompts. If AED voice prompt informs you that no shock is needed, immediately resume CPR.

16. When to stop CPR (keep the electrode pads on)

- a) When the injured or ill person has been handed over to the emergency services.
- b) When the injured or ill person has started moaning or breathing normally, lay him/her on his/her side in a recovery position and wait for the arrival of emergency services.

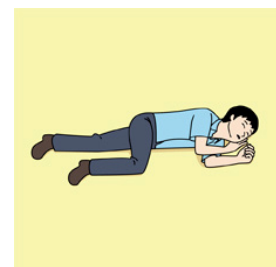

Preface

Thank you for purchasing the JRC JCY-1900 Voyage Data Recorder (VDR).

This equipment records the navigation data and the hull data of the vessel, as required by international standards. If a maritime accident occurred, this equipment helps investigators to investigate the cause and prevent the recurrence in the future.

- For the best operation, read this manual carefully before use.
- Keep this manual in a convenient place for future reference.
- Make use of this manual when experiencing operation difficulties.

To investigate the cause of maritime accident, the VDR records the navigation data and hull data of the vessel. If a maritime accident occurred, preserve the recorded data immediately.

In case a maritime accident occurred, please preserve the recorded data according to the procedure described in "Operation Guide" of page xx.

[NOTE]

The VDR erases old data that has been stored for a certain period of time and overwrites new data. If a maritime accident occurred, please take appropriate actions. Otherwise, the recorded data at the time of accident will be erased automatically.

The recorded data is stored for the following period of time.

- The fixed protective capsule unit: 48 hours (2 days)
- The float-free capsule unit: 48 hours (2 days)
- The international storage: 720 hours (30 days)

- This manual uses the following notations.

Notation	Description
[NOTE]	Indicates a note.
[Information]	Indicates a supplementary explanation.
[]	Indicates a button, tab, or other on-screen item that can select by tapping it.



(Blank page)

Before Operation

Pictorial indication

Various pictorial indications are included in this manual and are shown on this equipment so that you can operate them safely and correctly and prevent any danger to you and / or to other persons and any damage to your property during operation. Such indications and their meanings are as follows.

Please understand the meanings of pictorial indication before you read this manual.

 DANGER	Indicates that it is probable that incorrect equipment operation due to negligence cause death or a serious injury.
 WARNING	Indicates that it is possible that incorrect equipment operation due to negligence cause death or a serious injury.
 CAUTION	Indicates that it is probable that incorrect equipment operation due to negligence cause human injury or property damage.

Examples of pictorial indication



The  mark indicates CAUTION (including DANGER and WARNING). Detailed contents of prohibited action (“Electric Shock” in the example on the left) is shown in the mark.



The  mark indicates prohibition. Detailed contents of the prohibited action (“Disassembling Prohibited” in the example on the left) is shown in the mark.





The  mark indicates instruction. Detailed contents of the instruction (“Disconnect the power plug” in the example on the left) is shown in the mark.







Warning Label









There is a warning label on the front panel of equipment. Do not try to remove, break or modify the label.







(Blank page)









Precautions

 DANGER	
	<p>The prohibited matter of a battery and a lithium battery.</p> <ul style="list-style-type: none"> - To short-circuit the + pin and - pin - Using for non-specified applications - Disassembling, modifying, destroying - Throwing into fire, heating - Using expired battery <p>There is a danger that causes leakage of fluid, generation of heat, fire, explosion, destruction, or injury by heat.</p>

 WARNING	
	<p>Do not attempt inspections or repairs on the internal part of the equipment by yourself. Inspections or repairs by anyone other than qualified maintainers may cause a fire or electric shock.</p> <p>Please contact our head office, or a nearby branch or local office to request servicing.</p>
	<p>Do not disassemble or remodel this equipment.</p> <p>Such action may cause a fire, electric shock, or malfunction of the equipment.</p>
	<p>Do not use any power supply voltage other than the specified one.</p> <p>Such action may cause a fire, electric shock, or malfunction of this equipment.</p>
	<p>Turn off power supply switch before connecting or disconnecting cables to any external equipment.</p> <p>Not turning it off may cause a fire or an electric shock.</p>
	<p>If the power supply cable damaged, please contact our head office, or a nearby branch or local office to request servicing.</p> <p>The use of damaged cables may cause a fire or an electric shock.</p>
	<p>If water entered the equipment, make sure to turn off the main power, open the circuit breaker, and please contact our head office, or a nearby branch or local office to request servicing.</p> <p>Using it as it is may cause a fire, electric shock, or malfunction.</p>

 <h1 style="margin: 0;">WARNING</h1>	
	<p>If equipment malfunctions, make sure to turn off the main power, open the circuit breaker, and please contact our head office, or a nearby branch or local office to request servicing.</p> <p>The continuous use of the equipment may cause a fire or electric shock.</p>
	<p>The recording control unit (NDV-1900) has a built-in battery.</p> <p>The battery needs to be replaced periodically. If using continually an expired battery, a fire may occur.</p>
	<p>Never replace the battery by yourself.</p> <p>Replacement by anyone other than qualified maintainers may cause a fire, an electric shock, or a malfunction.</p> <p>Please contact our head office, or a nearby branch or local office to request servicing.</p>
	<p>The recording control unit (NDV-1900) has a built-in battery.</p> <p>The battery contains dilute sulfuric acid. If the liquid that has leaked from the battery adhered with your clothes or skin, wash with clean water. If the liquid entered your eyes, immediately wash with clean water and see a doctor.</p>
	<p>The recording control unit (NDV-1900) has a built-in battery.</p> <p>Do not discard because used batteries are recycled. Please contact our head office, or a nearby branch or local office to request servicing.</p>
	<p>The underwater acoustic beacon of fixed protective capsule unit and float-free capsule unit has a built-in lithium battery.</p> <p>Do not discard because used lithium batteries are recycled. Please contact our head office, or a nearby branch or local office to request servicing.</p>
	<p>If disposing of this equipment, be sure to abide by applicable local laws and regulations.</p>

 WARNING	
	<p>The recording control unit (NDV-1900) has the power socket. When you connect the power plug to the power socket, insert it firmly. Failure to do so may cause fire, burns or electric shock.</p>
	<p>The recording control unit (NDV-1900) has the power socket. Clean dust from the power plug. Failure to do so may cause fire.</p>
	<p>Do not inset or drop any foreign objects such as metallic pieces into an air vent or opening. Otherwise, it may cause a fire, electric shock or malfunction.</p>
	<p>Do not place heavy objects on the power cable or do not bend the power cable by force. Otherwise, the power cable is damaged, and it may cause a fire, electric shock.</p>
	<p>Do not put the container with the liquid on or near this equipment. Otherwise, if the liquid spill or come in this equipment, it may cause a fire, electric shock, or malfunction.</p>
	<p>If there is anything abnormal such as smoke, strange smell or unusual heat is emitted, turn off the POWER switch of the equipment immediately and pull out the power cable. Then, please contact our head office, or a nearby branch or local office to request servicing. The continued use of the equipment may cause a fire or electric shock.</p>

 <h1 style="margin: 0;">CAUTION</h1>	
	<p>This equipment has warning labels. Do not try to remove, break or modify the label.</p>
	<p>Do not install the equipment on the location where infringed by water, humidity, steam, dust, or soot. Otherwise, it may cause a fire, electric shock, or malfunction.</p>
	<p>Do not touch this equipment, if hands or gloves are wet with water. Otherwise, it may cause an electric shock, or a malfunction.</p>
	<p>Be sure to hold power supply plug when pulling it out of socket Pulling the power cable without holding the plug may damage the cable and may cause a fire or an electric shock.</p>
	<p>Although the shape of power socket is for 100VAC, it directly outputs the voltage (100 to 220VAC) that is being input to the RCU. Do not connect equipment for 100VAC, if 220VAC is being input. Otherwise, a malfunction may occur.</p>
	<p>If the equipment is splashed with freshwater or seawater, wipe it immediately. Otherwise, it may cause a failure or operational malfunctions.</p>
	<p>Do not use any organic solvents such as thinner or benzene to clean the surface. These agents can damage the surface coating. Be sure to remove dirt and dust from the surface and wipe it using a clean dry cloth.</p>
	<p>Do not carry out the tap of the screen by the sharp object. Otherwise, the screen may be damaged.</p>

 **CAUTION**

Do not block up the air vent of this equipment.
Otherwise, the inside of equipment is filled with heat, and it may cause fire or malfunction.



Do not install the equipment on the unstable place such as on the shaky stand or inclined surface.
Otherwise, it may drop or fall down, resulting in an injury or malfunction.

(Blank page)

Operation Guide

When a Maritime Accident Occurred

- If a maritime accident occurred, preserve the recorded data in the VDR until the time of accident.
- The fixed protective capsule unit or the float-free capsule unit store 48 hours data. The internal storage of RCU store 720 hours data. The VDR continues the recording after an accident, so the recorded data may be overwritten.

If a maritime accident occurred, immediately grasp the situation and preserve the recorded data in the VDR. Follow the directions of the relevant authorities as to whether to stop or restart the VDR operation.

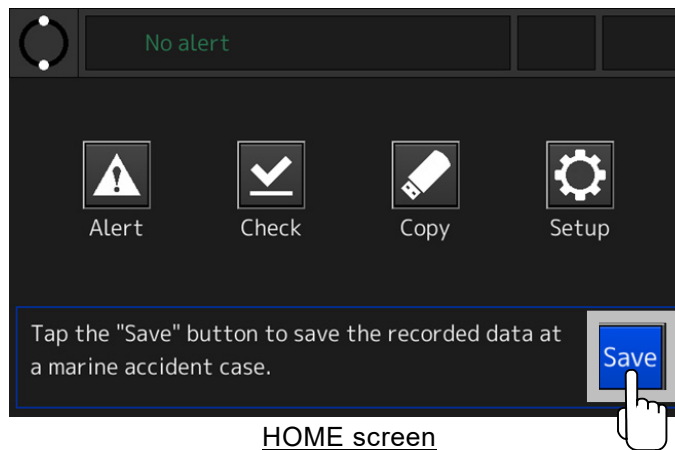

HOME screen



SAVE screen

If a maritime accident occurred, tap the [Save] button on the HOME screen and preserve the recorded data according to the following procedure.

1. Preserving the recorded data

So that the VDR does not overwrite the recorded data, preserve the recorded data in the internal storage of RCU.

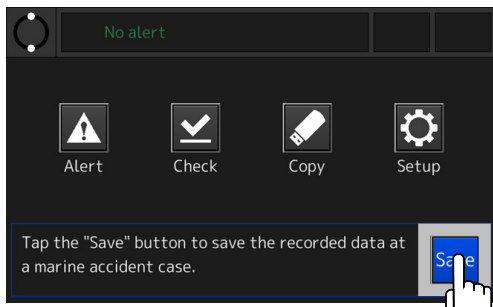

1) Tap the [Save] button in the HOME screen.



2) Tap the [Protect] button in the SAVE screen.

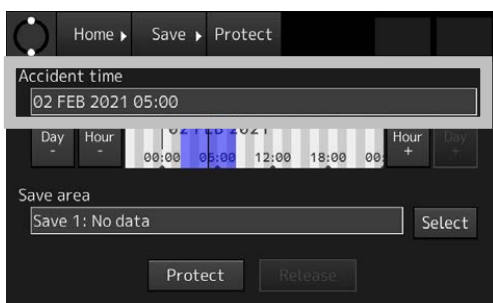

3) Check that the date and time of [Accident time] field in the DATA PROTECT screen is the current time.

[Information]
Usually, it is not necessary to change because the current time is set automatically.



4) Tap the [Protect] button, then the recorded data is preserved.

2. Stop the data recording

Stop the recording of data in the fixed protective capsule unit, float-free capsule unit, and internal storage of the RCU.

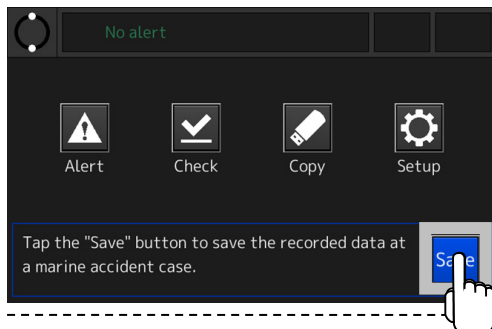

1) Tap the [Save] button in the HOME screen.



2) Tap the [Record stop/start] button in the SAVE screen.

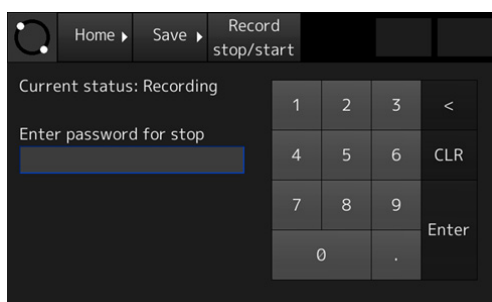

3) Enter the password by the numeric keypad in the PASSWORD INPUT screen.

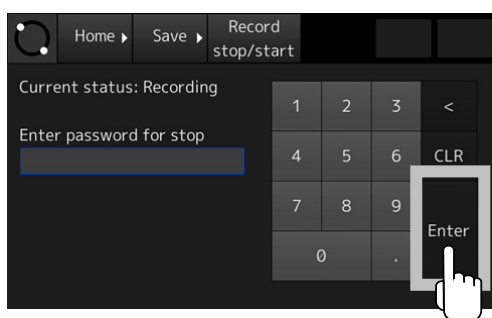

4) Tap the [Enter] button, then the data recording is stopped.

(Blank page)

Exterior of System Components



Recording Control Unit (RCU)



Operation Panel Unit (OPU)



Float-free Capsule unit (FFC)
Complying with MSC.494(104)



Float-free Capsule unit (FFC)
Before complying with MSC.494(104)





Fixed Protective Capsule Unit (FPC)



Microphone



Waterproof microphone



Junction box

Contents

Preface	x
Before Operation	xii
Precautions	xiv
Operation Guide	xx
Exterior of System Components	xxiv
Contents	xxvi
Abbreviations and Terms	xxx
Chapter 1 Outline of the Equipment	1
1.1 Functions.....	1
1.2 Features	1
1.3 Configuration.....	2
1.4 System Diagram.....	4
Chapter 2 Names and Functions	5
2.1 NDV-1900 Recording Control Unit	5
2.2 NCG-1900 Operation Panel Unit.....	7
Chapter 3 Turn On and Off the System	9
3.1 Turn On the System.....	9
3.2 Turn Off the System.....	14
Chapter 4 Operation Method	19
4.1 Basic On-screen Operations	19
4.1.1 About the button	19
4.1.2 Screen transition list.....	20
4.1.3 Screen scrolling	21
4.1.4 Item selection.....	21
4.1.5 Number input	22
4.2 HOME Screen	23
4.3 Checking the Alerts and Information	27
4.3.1 Definition of alerts	27
4.3.2 Notification of alerts and information	28
4.3.3 When new alert occurs	30
4.4 Displaying the Alert List - [Alert] Button	31
4.5 Copying the Recorded Data - [Copy] Button	33
4.6 Checking the Recorded Data - [Check] Button.....	38
4.6.1 The DATA CHECK screen	38
4.6.2 Checking the sensor data.....	40
4.6.3 Checking the image data.....	42
4.6.4 Checking the audio data.....	46
4.6.5 Checking the recording time.....	49
4.6.6 Saving the judgment results	50
4.6.7 Displaying the data check history	51
4.7 System Setup - [Setup] Button	52
4.7.1 The SYSTEM SETUP screen	52

4.7.2	Adjusting the screen brightness.....	53
4.7.3	Adjusting the volume of screen touch sound	55
4.7.4	Checking the replacement parts	57
4.7.5	Checking the system information.....	59
4.7.6	Controlling the remote access permission	61
4.7.7	Changing the password.....	64
4.8	Initial Setting of the Heading Angle - [Gyro I/F] Button.....	66
4.9	Actions to Take in the Event of an Accident - [Save] Button	68
4.9.1	Actions to take at the occurrence of accident	69
4.9.2	Preserving the recorded data at the occurrence of accident	70
4.9.3	Releasing the preserved data.....	73
4.9.4	Stop or restart the recording.....	76
4.10	Operations Using the Rotary Knob	80
Chapter 5	About Float-free Capsule	81
5.1	EPIRB Transmission Status.....	86
5.2	Manual Operating and Activation	87
5.2.1	NDH-339B In case of Float-free capsule complying with MSC.494(104)	87
5.2.2	NDH-339 In case of Float-free capsule before complying with MSC.494(104).....	88
5.3	EPIRB Function Testing -NDH-339B In case of complying with MSC.494(104)-.....	90
5.3.1	NORMAL SELF-TEST	90
5.3.2	EXTENDED SELF-TEST	92
5.4	EPIRB Function Testing -NDH-339 In case of before complying with MSC.494(104)-	95
5.4.1	NORMAL SELF-TEST	95
5.4.2	EXTENDED SELF-TEST including GPS-test.....	97
5.5	Attention point at mounting the capsule	98
5.5.1	Visual inspection	99
5.5.2	Check the expire date	99
Chapter 6	Maintenance and Inspection	101
6.1	Daily Maintenance	101
6.1.1	Cleaning.....	101
6.1.2	Checking the expiration date of battery	102
6.1.3	The list of the replacement parts	102
6.1.4	Changing the vessel specific information and the connected device	102
6.2	Periodic Inspection	102
6.3	Troubleshooting.....	103
6.3.1	In case of trouble	103
6.3.2	List of alerts	104
6.3.3	List of information.....	109
Chapter 7	After-sale Services	111
7.1	When Requesting a Repair.....	111
7.2	About Disposal	113
7.2.1	About disposal of these equipment.....	113
7.2.2	About disposal of the used batteries.....	113
7.2.3	About the China RoHS	114
Chapter 8	Specifications	115

8.1 NDH-338 Fixed Protective Capsule Unit	115
8.2 NDH-339/NDH-339B Float-free Capsule Unit	117
8.2.1 NDH-339B In case of Float-free capsule complying with MSC.494(104)	117
8.2.2 NDH-339 In case of Float-free capsule before complying with MSC.494(104).....	119
8.3 NDV-1900 Recording Control Unit.....	121
8.4 NCG-1900 Operation Panel Unit	124
8.5 NVT-181 Microphone Unit	125
8.6 NVT-182 Waterproof Microphone Unit.....	126
8.7 NCT-83 Digital Signal Converter (64CH)	127
8.8 NCT-82 Digital Signal Converter (32CH)	128
8.9 NWP-69 Frame Grabber Unit	129
8.10 NCT-84 Data Acquisition Unit.....	130
8.11 NQE-7700A Junction Box.....	131
8.12 General Environmental Condition	132
8.13 Software license information.....	134
Chapter 9 Outside Drawings	135
9.1 NDH-338 Fixed Protective Capsule Unit	135
9.2 NDH-339/NDH-339B Float-free Capsule Unit	136
9.2.1 NDH-339B In case of Float-free capsule complying with MSC.494(101)	136
9.2.2 NDH-339 In case of Float-free capsule before complying with MSC.494(101).....	137
9.3 NDV-1900 Recording Control Unit.....	138
9.4 NCG-1900 Operation Panel Unit	139
9.5 NVT-181 Microphone Unit	140
9.6 NVT-182 Waterproof Microphone Unit.....	142
9.7 NCT-83 Digital Signal Converter (64CH)	144
9.8 NCT-82 Digital Signal Converter (32CH)	145
9.9 NWP-69 Frame Grabber Unit	146
9.10 NCT-84 Data Acquisition Unit.....	148
9.11 NQE-7700A Junction Box.....	149

(Blank page)

Abbreviations and Terms

Abbreviations

AIS	Automatic Identification System
ARB	Audio Recording Board
BAM	Bridge Alert Management
COSPAS	COsmicheskaya Sistyema Poiska Avariynich Sudov (Space System for the Search of Vessels in Distress)
DAB	Data Acquisition Board
DAU	Data Acquisition Unit
DSC	Digital Signal Converter
ECDIS	Electronic Chart Display and Information System
EPIRB	Emergency Position Indicating Radio Beacon
FFC	Float-free Capsule unit
FGB	Frame Grabber Board
FGU	Frame Grabber Unit
FPC	Fixed Protective Capsule unit
GPS	Global Positioning System
HMI	Human Machine Interface
HRU	Hydrostatic Release Unit
IEC	International Electrotechnical Commission
IMO	International Maritime Organization
LCD	Liquid Crystal Display
LTM	Long-term Medium
MCB	Main Control Board
OPU	Operation Panel Unit
PSU	Power Supply Unit
RCU	Recording Control Unit
SARSAT	Search and Rescue Satellite-Aided Tracking System
SBM	Shore Based Maintenance
TB	Terminal Board
UPS	Uninterruptible Power Supply
VDR	Voyage Data Recorder

Terms

A.861	IMO Performance Standard for VDR
HDT	Heading true sentence header ID of IEC61162-1
IEC60945	General Requirements
IEC61162	Maritime navigation and radiocommunication equipment and systems - Digital interfaces -
IEC61162-1	Part 1: Single talker and multiple listeners
IEC61162-2	Part 2: Single talker and multiple listeners, high-speed transmission
IEC61162-450	Part 450: Multiple talkers and multiple listeners - Ethernet interconnection
IEC61996	Maritime navigation and radiocommunication equipment and systems - Shipborne voyage data recorder (VDR) -
IEC61996-1	Part 1: Performance requirements, methods of testing and required test results
IEC62288	Maritime navigation and radiocommunication equipment and systems – Presentation of navigation-related information on shipborne navigational displays – General requirements, methods of testing and required test results
IEC62923	Maritime navigation and radiocommunication equipment and systems - Bridge alert management -
IEC62923-1	Part 1: Operational and performance requirements, methods of testing and required test results
IEC62923-2	Part 2: Alert and cluster identifiers and other additional features
UXGA	Ultra eXtended Graphics Array Display resolution: 1600 x 1200 pixels
VBW	Dual ground/water speed sentence header ID of IEC61162-1
VESA DMTS	Video Electronics Standards Association - Discrete Monitor Timings Standard
WVGA	Wide Video Graphics Array Display resolution: 800 x 640 pixels

Chapter 1 Outline of the Equipment

1.1 Functions

This equipment records the navigation data and the hull data of the vessel, as required by international standards. If a maritime accident occurred, this equipment helps investigators to investigate the cause and prevent the recurrence in the future.

1.2 Features

- Fully compliant with the latest international standards

The JCY-1900 is fully compliant with the latest international standards for VDR such as IMO MSC.333(90) and IEC61996-1.

*Furthermore, it is necessary to install VDR complying with the MSC.494(104) standard 1 July 2022 or later, the Float-free capsule is complying with the standard

- Collection of the recorded data via the IP network.

The JCY-1900 has a data collection interface that is compliant with IEC61162-450. This interface allows this equipment to collect radar display images, ECDIS display images, and various sensor data via the IP network.

- Effective use of the recorded data

The recorded data collected by the JCY-1900 can distribute to systems via the IP network. The recorded data can display by the real-time monitoring software and contribute energy saving and a safety voyage.

Furthermore, the recorded data can save in the personal computer by the real-time monitoring software. The storage capacities need 32 GB to save the recorded data for 2 days.

1.3 Configuration

Table 1-1 shows the standard configuration list of this equipment.

Table 1-1 Standard configuration list

No.	Component Name	Type Name	Qty	Function
1	Recording Control Unit (RCU)	NDV-1900	1	<ul style="list-style-type: none"> - Output the recorded data to the fixed protective capsule unit, the float-free capsule unit - Recording data to the internal storage - Collecting the radar images, the audio data, and the sensor data - Managing and monitoring the VDR system - If AC input power is lost, it can record data for 2 hours by the built-in battery
	Main Control Board (MCB)	CDJ-2510		
	Audio Recording Board (ARB)	CHA-1900		
	Power Supply Unit (PSU)	CBM-221		
	Terminal Board (TB)	CQD-2281		
	Battery	CBN-80		
	Playback software for users	CYC-826	1	<ul style="list-style-type: none"> - Stored in the NDV-1900 - Including the real-time monitoring function
	Playback software for the accident investigators	CYC-825	1	<ul style="list-style-type: none"> - Stored in the NDV-1900 - For the accident investigators use
LAN cable	---	1	<ul style="list-style-type: none"> - Stored in the NDV-1900 - For the accident investigators use 	
2	Operation Panel Unit (OPU)	NCG-1900	1	<ul style="list-style-type: none"> - Equipped with 7-inch color LCD - Operating the VDR system by the touch panel - If new alert occurred, the detail of the alert is displayed - Equipped with a USB port
3	Fixed Protective Capsule unit (FPC)	NDH-338	1	<ul style="list-style-type: none"> - Recording data to the internal storage - If the ship has sunk under water, the underwater acoustic beacon is running
	Beacon unit	H-7ZZNA4138		

Table 1-1 Standard configuration list (continued)

No.	Component Name	Type Name	Qty	Function
4	Float-free Capsule unit (FFC)	NDH-339/ NDH-339B	1	<ul style="list-style-type: none"> - Recording data to the internal storage - If the ship has sunk under water, the capsule unit floats to the surface and transmits location information *To comply with MSC.494(104) which will be applied from 1 July 2022, it is necessary to install NDH-339B.
	Docking module	CMH-4339		
	Storage module	CDD-1339		
	HRU	H-7ZZNA4150		
5	Junction box	NQE-7700A	1	- For connecting NDH-339/NDH-339B
6	Microphone unit	NVT-181	4	- Recording the conversation in the bridge
Accessories				
7	Spare parts for RCU	H-7ZXNA4015	1	- Cooling fan and fuse for NDV-1900

Table 1-2 lists optional units for the VDR.

Table 1-2 Option units

No.	Component Name	Type Name	Function
1	Microphone unit	NVT-181	<ul style="list-style-type: none"> - Excluding the 4 units of standard configuration, the microphone can install 8 units of option units
2	Waterproof microphone unit	NVT-182	
3	Digital Signal Converter (DSC)	NCT-82 (32CH) or NCT-83 (64CH)	<ul style="list-style-type: none"> - Converts the dry contact signal into IEC61162-1 data and outputs them - If the optional CEF-60 add, this unit can convert analog signals
4	Data Acquisition Unit (DAU)	NCT-84	<ul style="list-style-type: none"> - Converts the input sensor data - Transmits the converted data via ethernet - Receives heading angle (synchronous/step) signals
5	Frame Grabber Unit (FGU)	NWP-69	<ul style="list-style-type: none"> - Captures the radar/ECDIS display image via RGB signal and converts to PNG image format - Transmits the converted image data to the RCU via ethernet
Accessories			
6	Spare parts for DSC	H-7ZXNA4017	- Fuse for NCT-82/83
7	Spare parts for FGU	H-7ZXNA4016	- Cooling fan and fuse for NWP-69
8	Spare parts for DAU	H-7ZXNA4018	- Fuse for NCT-84

1.4 System Diagram

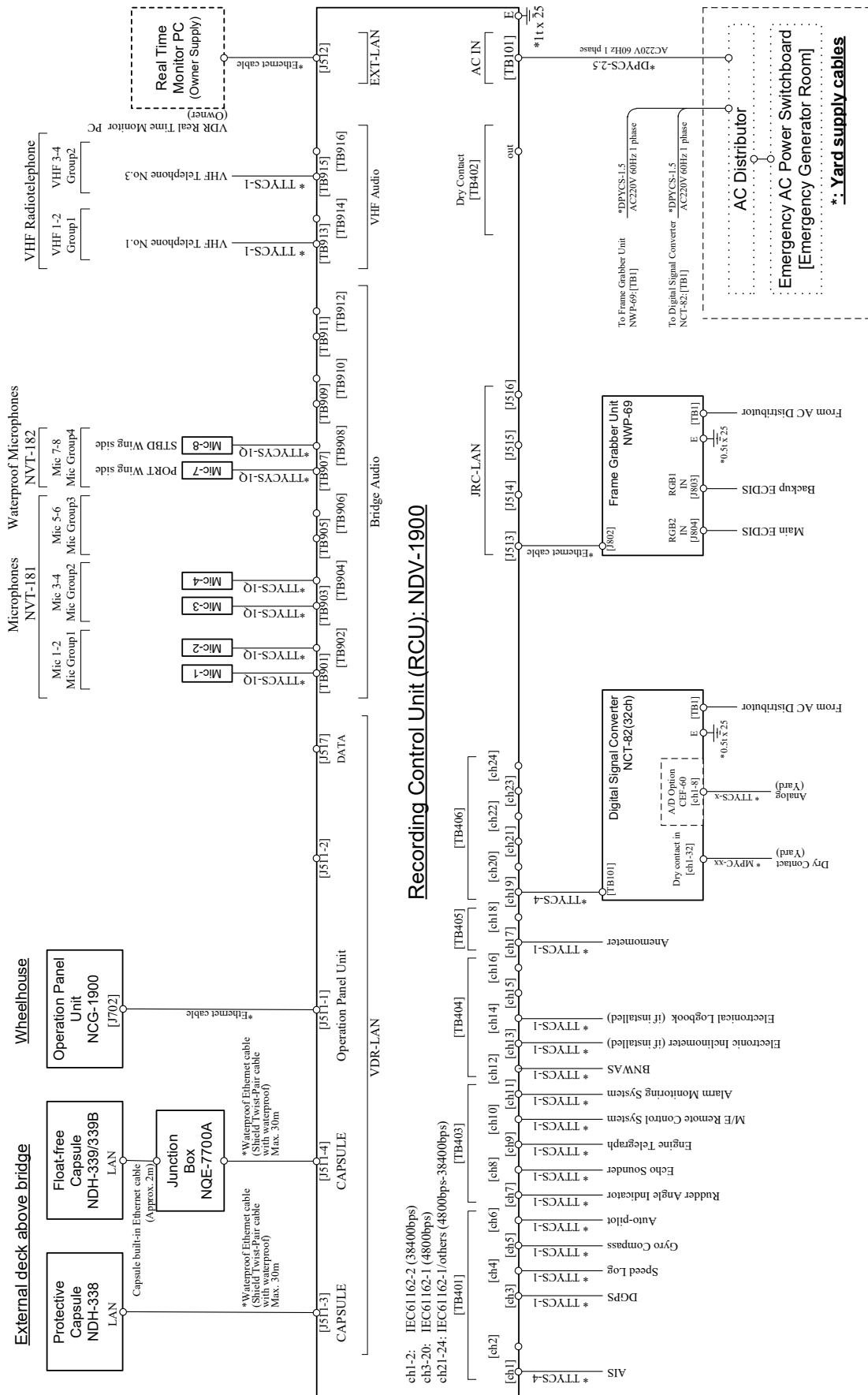

JCY-1900 VOYAGE DATA RECORDER: CONNECTION DIAGRAM

Figure 1-1 Example of system diagram

Chapter 2 Names and Functions

The following describes the name and function of each part of the VDR.

2.1 NDV-1900 Recording Control Unit

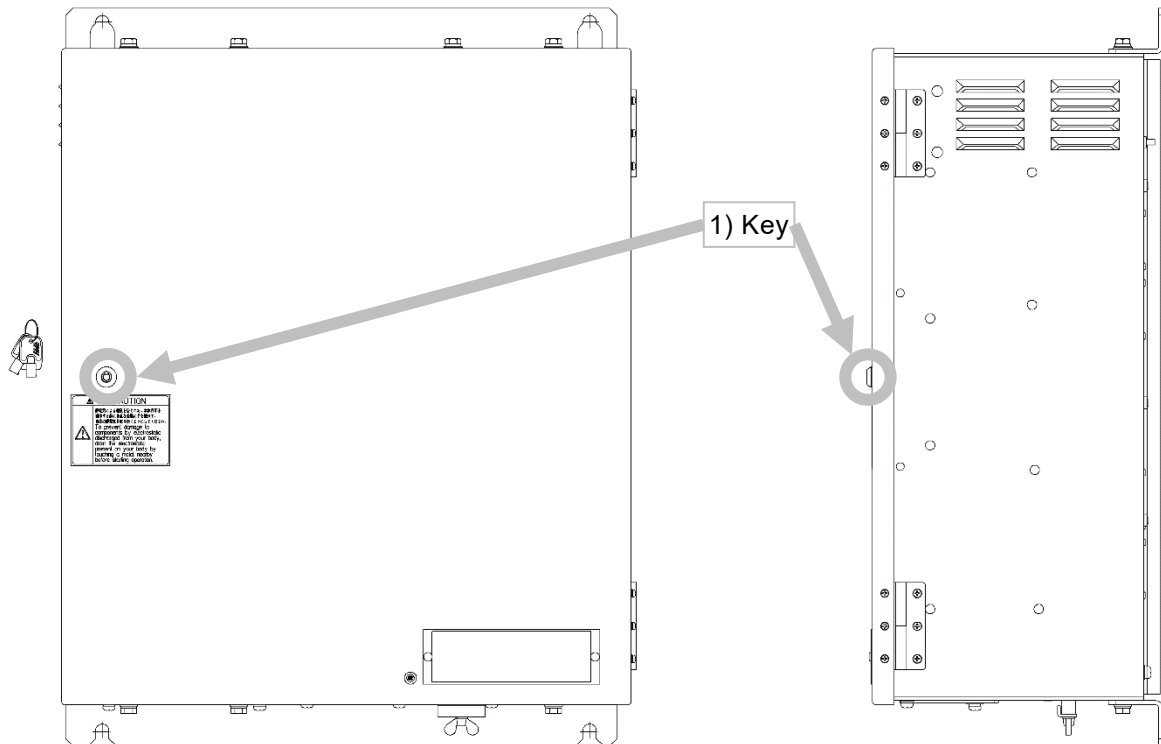

Figure 2-1 Recording Control Unit (when the front door is closed)

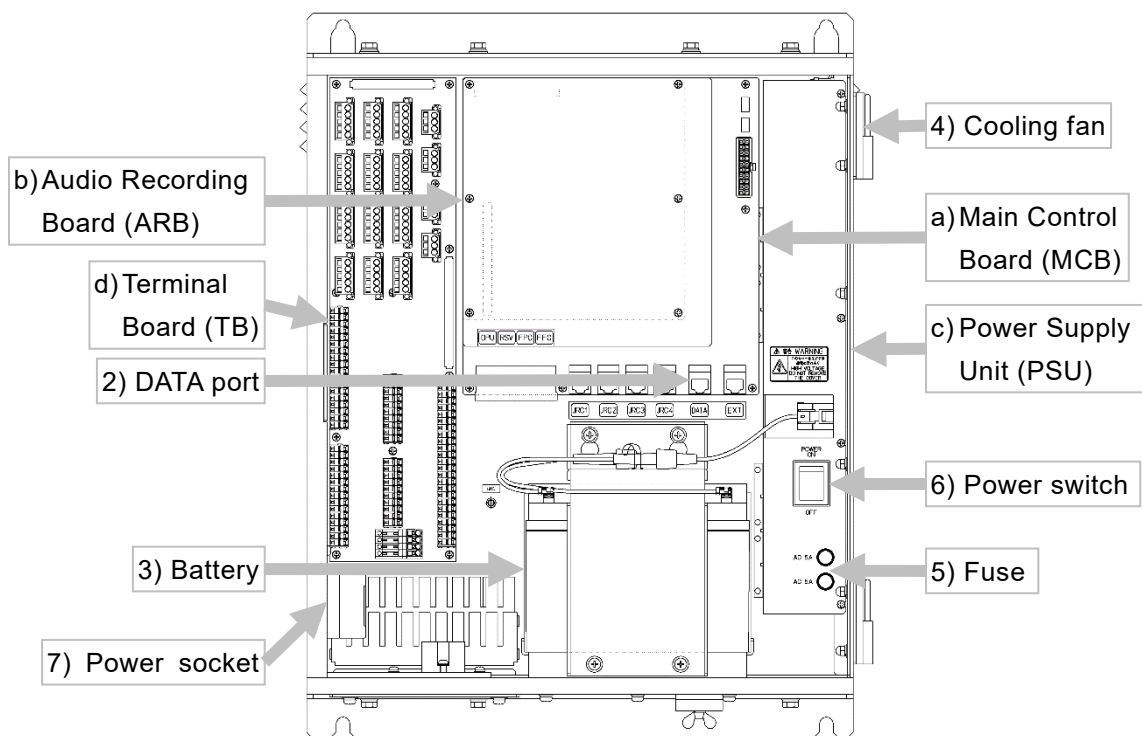

Figure 2-2 Recording Control Unit (when the front door is opened)



Table 2-1 Name and function of each part of the RCU

No.	Name	Description
1	Key	The key for the front door.
2	DATA port	The accident investigator uses to retrieve the recorded data from the VDR.
3	Battery	The battery becomes the backup power supply when an AC input power is lost. The battery can operate the following equipment for two hours. <ul style="list-style-type: none"> - Recording Control Unit - Fixed Protective Capsule unit - Float-free Capsule unit - Operation Panel Unit - Microphone, waterproof microphone
4	Cooling fan	Two cooling fans are installed.
5	Fuse	A 5A glass fuse is mounted to protect the AC input power line.
6	POWER switch	This is the main power switch of the RCU.
7	Power socket	This socket is for service engineer. The power voltage: AC 100 to AC 220V

Table 2-2 Name and function of each circuit of the RCU

No.	Name	Description
a	Main Control Board (MCB)	This board manages the VDR system.
b	Audio Recording Board (ARB)	This board processes the conversation of microphones and VHF communication.
c	Power Supply Unit (PSU)	This unit is the main power supply of the VDR system. This unit has a function of uninterruptible power supply.
d	Terminal Board (TB)	<ul style="list-style-type: none"> - Sensor data (IEC61162-1/2) terminal block - Microphone and VHF communication terminal block

CAUTION

	If the cooling fan failed, an alert is displayed on the Operation Panel Unit (OPU). Do not ignore this alert because the RCU may fail. Please be sure to replace the cooling fan. Please contact our head office, or a nearby branch or local office to request servicing.
	Although the shape of POWER SOCKET is for 100VAC, it directly outputs the voltage (100 to 220VAC) that is being input to the RCU. Do not connect equipment for 100VAC, if 220VAC is being input. Otherwise, a malfunction may occur.

2.2 NCG-1900 Operation Panel Unit



Figure 2-3 Name of each part of the Operation Panel Unit (OPU)

Table 2-3 Name and function of each part of the OPU

No.	Name	Function
1)	Touch panel	Tapping the touch panel, can operate the VDR system. - 7-inch wide Liquid Crystal Display - Resolution: WVGA 800 x 480 pixel
2)	Speaker	Sounds a display tap sound and plays back the recorded conversation.
3)	Rotary knob	The rotary knob can adjust the screen brightness. Furthermore, when touch panel failed, the OPU operate with the rotary knob. <div style="border: 1px solid black; padding: 5px; margin-top: 10px;">[Information] If the rotary knob is held down for 5 seconds, the function changes into the rotary knob operation mode. In the rotary knob operation mode, the OPU cannot operate with the touch panel.</div>
4)	HOME button	If you would like to return to HOME screen, push the HOME button. Furthermore, in the rotary knob operation mode, if the HOME button is pushed, the function changes into the touch panel operation mode.
5)	USB port	If you would like to copy data from internal storage, plug a FAT32 formatted USB flash drive in this port. This port is covered with a cap.

(Blank page)

Chapter 3 Turn On and Off the System

3.1 Turn On the System

1. Start the Recording Control Unit (RCU)
 - 1) Unlock and open the front door.
 - 2) Turn on the POWER switch.
 - 3) After approximately 2 minutes, make sure that the MCB's LED (SYS., REC.) lights up in green.

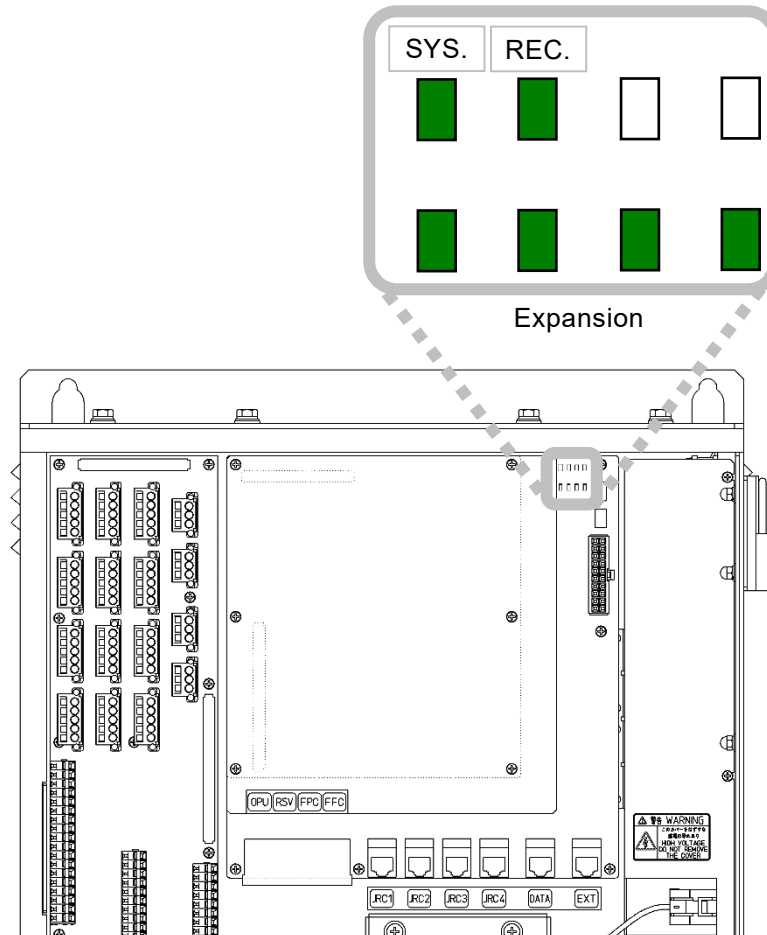

Figure 3-1 LED position of the MCB

4) The OPU starts up and displays the startup screen to show in Figure 3-2.

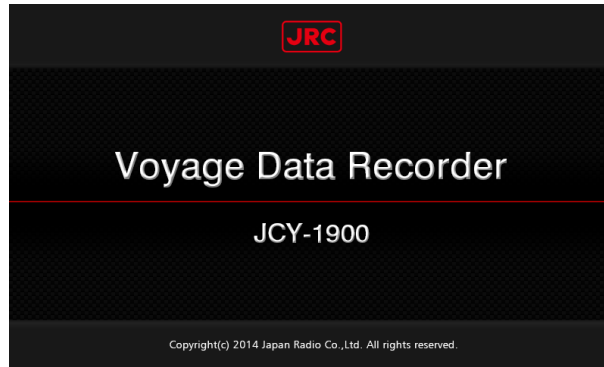

Figure 3-2 Startup screen

5) Close and lock the front door.

[Information]

If the RCU's POWER switch turns on, the following units automatically turn on.

- Operation Panel Unit (OPU)
- Fixed Protective Capsule unit (FPC)
- Float-free Capsule unit (FFC)
- Microphone unit
- Waterproof microphone unit

2. Digital Signal Converter (DSC) - Option

1) Remove the four setscrews from the front cover.

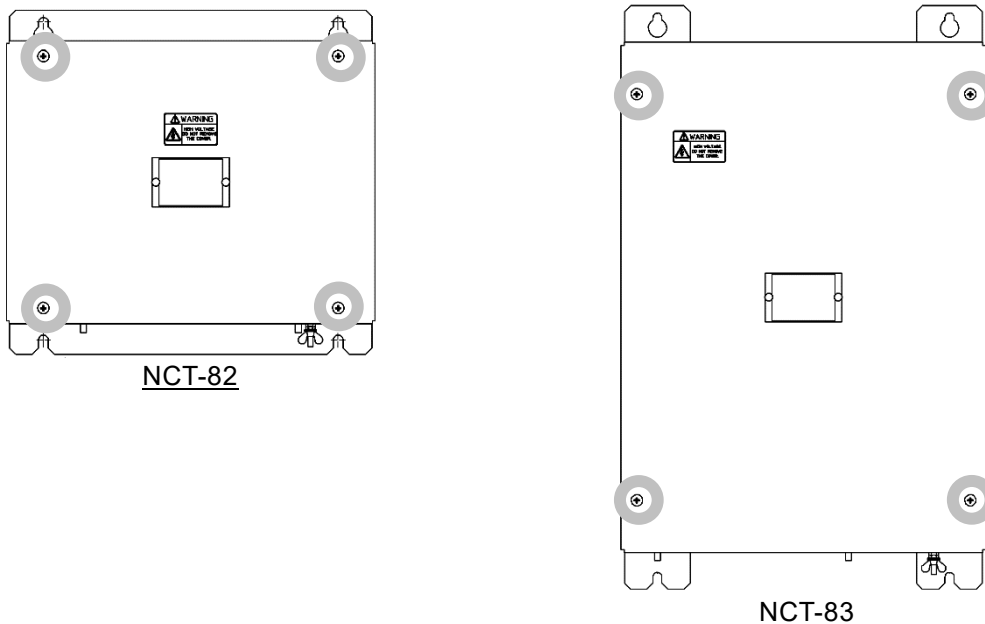

Figure 3-3 The screw position of the DSC

2) Turn on the POWER switch.

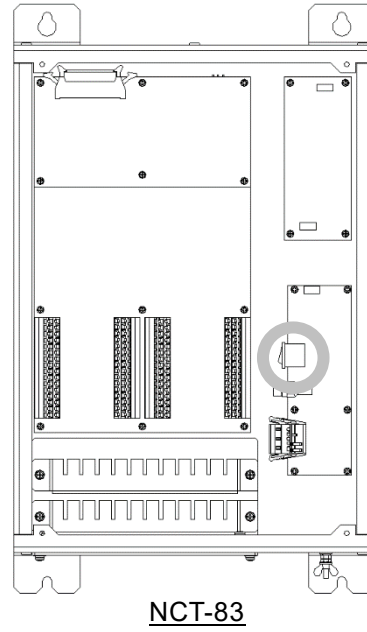
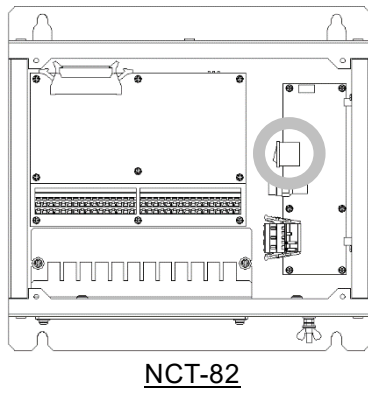

Figure 3-4 The power switch position of the DSC

3. Data Acquisition Unit (DAU) - Option

1) Remove the four setscrews from the front cover.

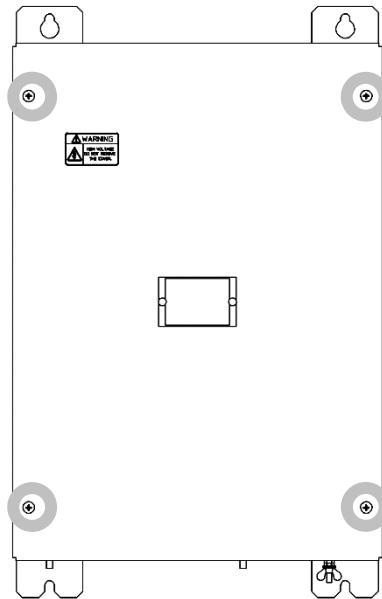

Figure 3-5 The screw position of the DAU

- 2) Turn on the POWER switch.

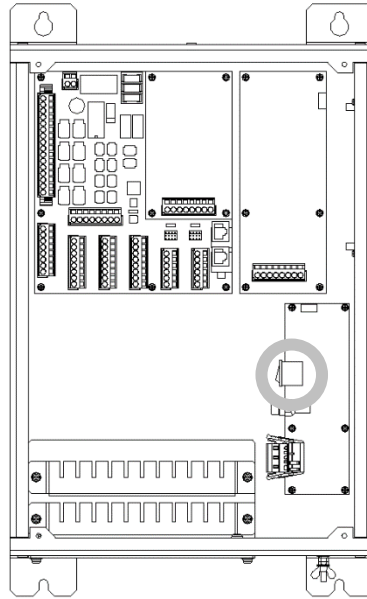

Figure 3-6 The power switch position of the DAU

4. Frame Grabber Unit (FGU) - Option

- 1) Turn on the POWER switch of the front panel.

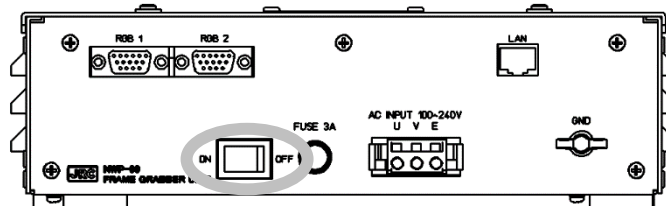

Figure 3-7 The power switch position of the FGU

5. Check the VDR system starts up normally on the OPU screen.

If the VDR system starts up normally, the OPU displays the HOME screen.

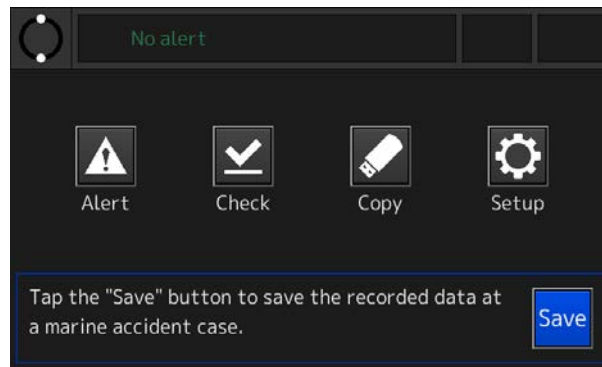

Figure 3-8 HOME screen

When an alert occurs, rectify it according to the procedure described in “4.3 Checking the Alerts and Information”.

[Information]

If the optional DAU is added, an alert occurs in the start-up because the VDR system is not setting the initial heading angle data. See “4.8 Initial Setting of the Heading Angle” and set the initial heading angle data.

3.2 Turn Off the System

[NOTE]

Do not turn off the circuit breaker of the power distribution board when the RCU is in operation. Otherwise, the uninterruptible power supply is activated and the VDR system operates in the battery.

[NOTE]

Do not stop the system unless the following case:

- During essential maintenance while the vessel is in port.
- When the vessel is laid-up.
- Upon request by an investigation authority, for example after the vessel had been involved in a marine incident.

1. Stop the RCU

- 1) Unlock and open the front door.
- 2) Turn off the POWER switch.
- 3) After approximately one minute, make sure that the MCB's LED goes out.
- 4) Check that the OPU's screen disappears.
- 5) Close and lock the front door.

[Information]

If the RCU turn off, the following units turn off automatically.

- Operation Panel Unit (OPU)
- Fixed Protective Capsule unit (FPC)
- Float-free Capsule unit (FFC)
- Microphone unit
- Waterproof microphone unit

2. Digital Signal Converter (DSC) - Option

1) Remove the four setscrews from the front cover.

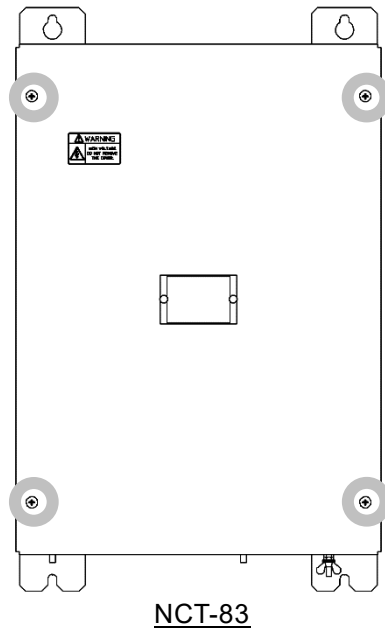
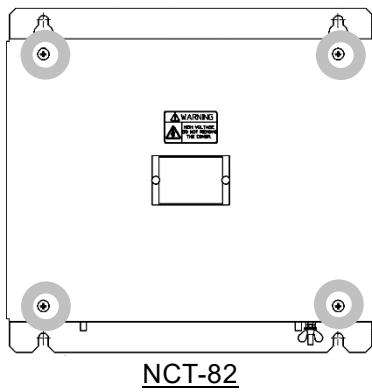

Figure 3-9 The screw position of the DSC

2) Turn off the POWER switch.

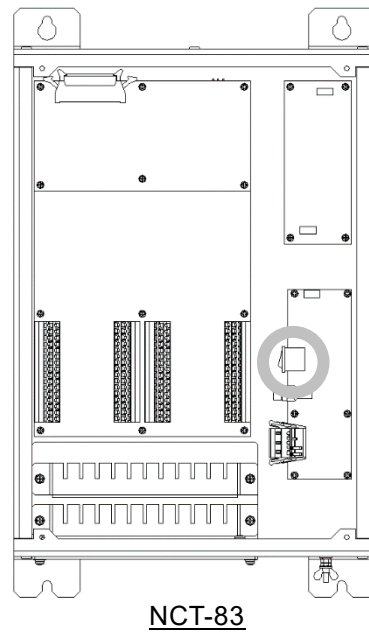
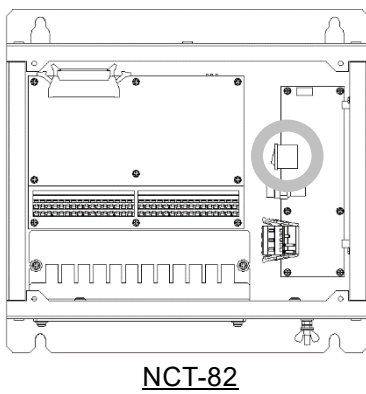

Figure 3-10 The power switch position of the DSC

3. Data Acquisition Unit (DAU) - Option

- 1) Remove the four setscrews from the front cover.

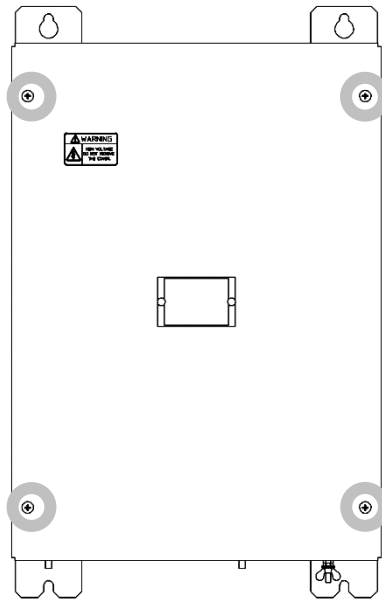

Figure 3-11 The screw position of the DAU

- 2) Turn off the POWER switch.

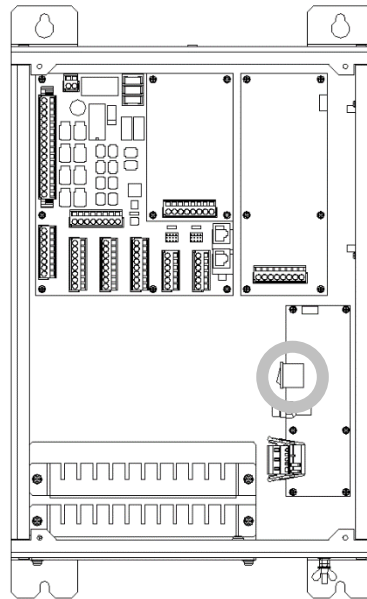

Figure 3-12 The power switch position of the DAU

4. Frame Grabber Unit (FGU)

- 1) Turn off the POWER switch of the front panel.

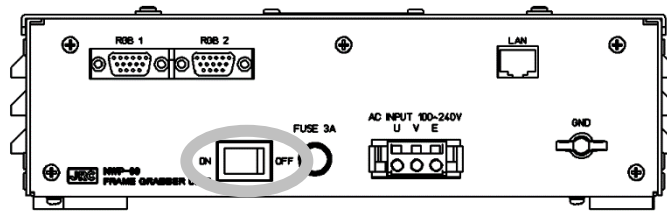

Figure 3-13 The power switch position of the FGU

[Information]

The POWER switch of following optional units always can keep ON. After the RCU turned off, the following optional units can turn off with the circuit breaker.

- Digital Signal Converter (DSC)
- Data Acquisition Unit (DAU)
- Frame Grabber Unit (FGU)

(Blank page)

Chapter 4 Operation Method

Operation of the VDR system other than turn on and off are performed by the OPU.

 CAUTION	
	Do not carry out the tap of the screen by the sharp object. Otherwise, the screen may be damaged.

4.1 Basic On-screen Operations

4.1.1 About the button

Operation is performed by tapping the on-screen buttons.

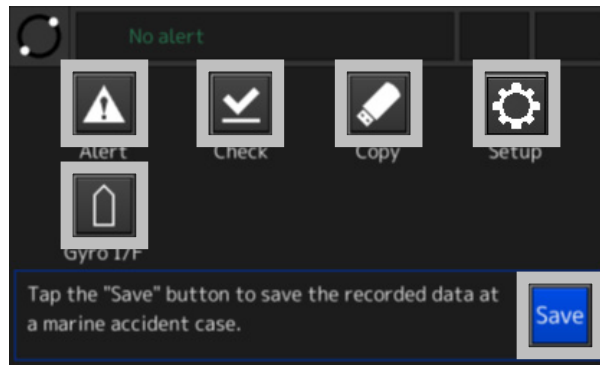

Figure 4-1 On-screen button

The color of on-screen button indicates whether the button is valid.

The operable button



Periphery frame: Black
Text and figure: White

The inoperable button



Periphery frame: Gray
Text and figure: Gray

Figure 4-2 Operable button and inoperable button

4.1.2 Screen transition list

The screen transition list is displayed to the top of each function screen. Looking at the screen transition list, the current screen can check what is displaying. Figure 4-3 shows [Home] - [Check] - [Image] - [Data check].

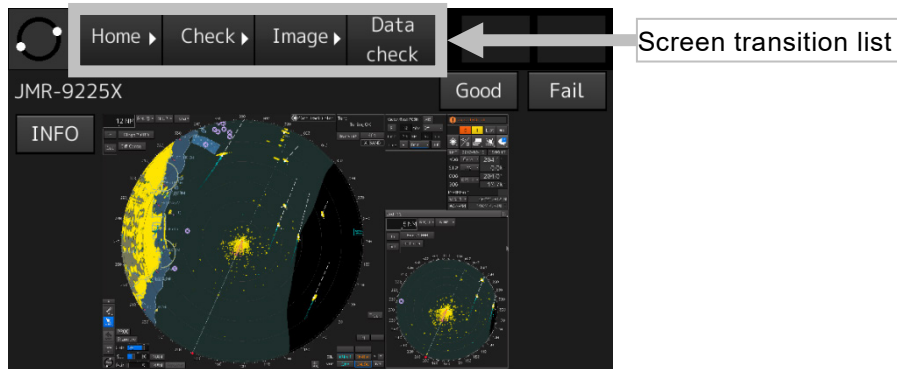

Figure 4-3 Screen transition list

Tapping the button of screen transition list, can move to the desired screen.

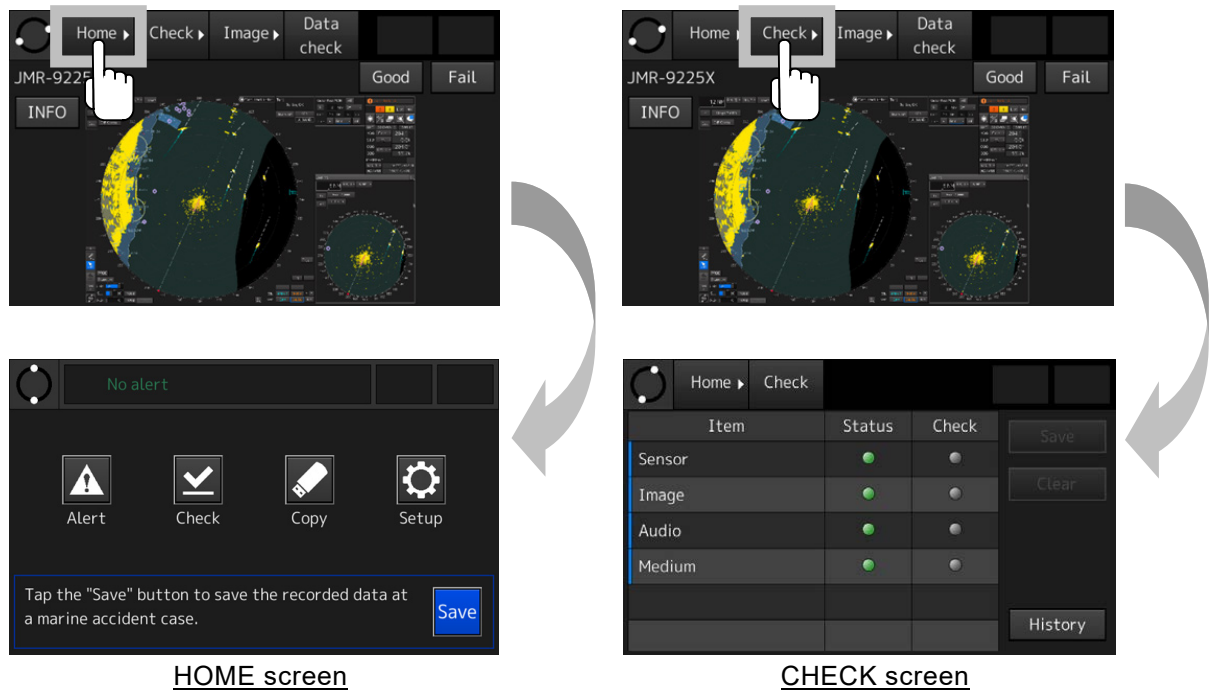

Figure 4-4 Usage in the button of screen transition list

4.1.3 Screen scrolling

If the screen scrollable, the [▲] button, [▼] button, and the display position indicator are displayed.

Tapping the [▲] button, the list scrolls up. Tapping the [▼] button, the list scrolls down. The display position indicator shows an approximate position of the selected item on the entire item list.

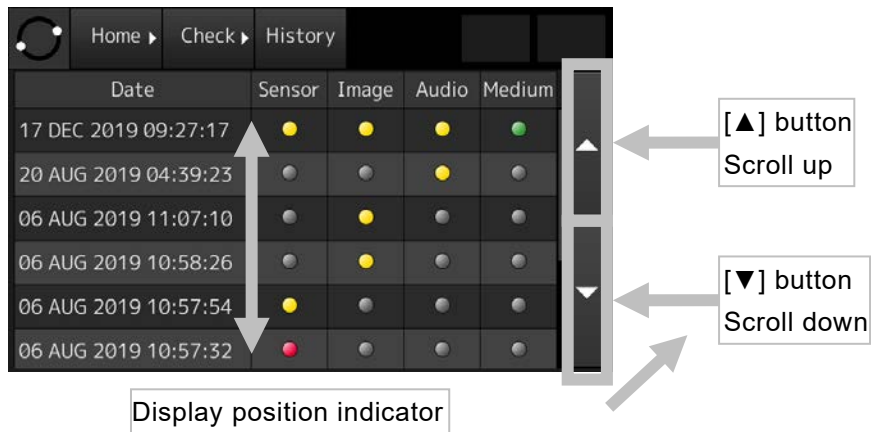

Figure 4-5 Screen scrolling

4.1.4 Item selection

If the operation indicator is displayed on the left of the list, the item is selectable. Tapping the item, displays the details.

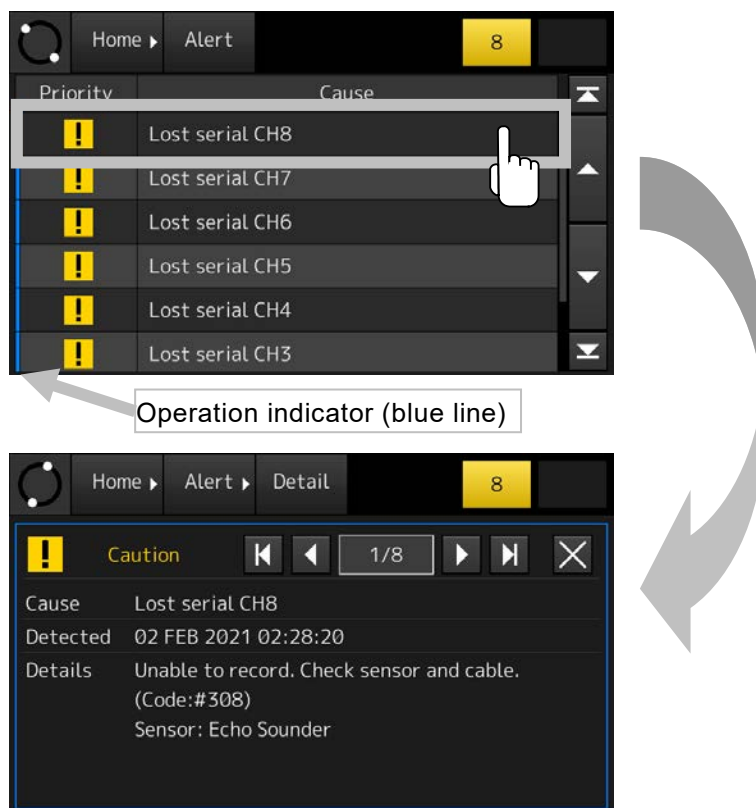

Figure 4-6 Item selection

4.1.5 Number input

The number input conducts by the on-screen numeric keypad. The input numbers and the period are displayed to the number input box. But the password is displayed with “●”.

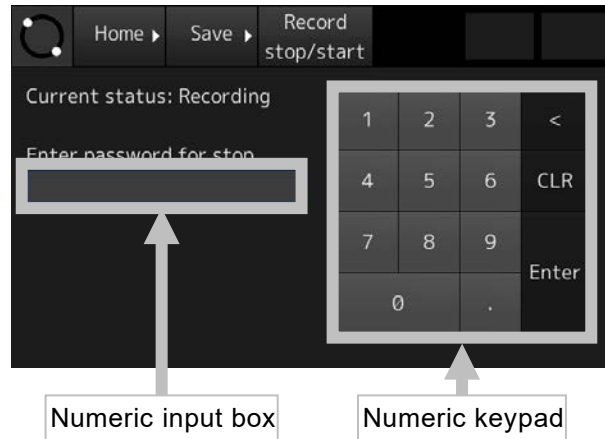

Figure 4-7 Number input

Table 4-1 Numeric keypad functions

Button	Function	Description
0 to 9	Number	These buttons input number.
.	Period	This button input a period.
<	Backspace	This button deletes the character to the left of the cursor.
CLR	Clear	This button deletes the all character of the numeric input box.
Enter	Enter	This button decides the characters of the numeric input box.

4.2 HOME Screen

The HOME screen is the VDR's main screen. The VDR system displays each function screen from the HOME screen.

[Information]

If nothing is operated for 10 minutes, it returns to the HOME screen automatically. However, if the ALERT CHECK screen is displayed, it doesn't return to the HOME screen.

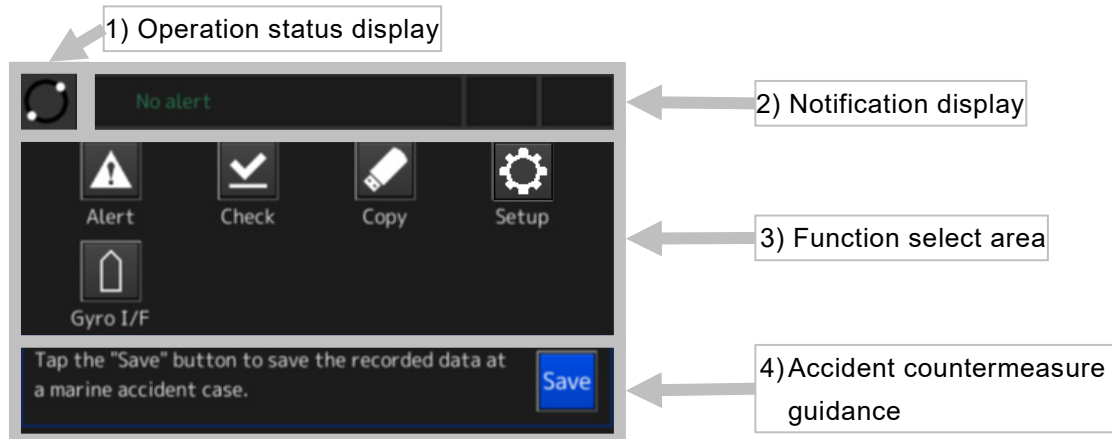

Figure 4-8 HOME screen

1. Operation status display

Indicates the operation status of the VDR system. If the VDR system is in operation, two white circles are moving. If these white circles stopped, it indicates that the VDR system is stopped with an abnormal state.

2. Notification display

Displays the currently occurring alert. See “4.3 Checking the Alerts and Information”.

3. Function select area

Tapping the function button, each function screen is displayed. See Table 4-2 for the function of each button.

Table 4-2 Function button





Button	Function	Description
 Alert	Checking the alert	Displays the ALERT screen. Takes actions to the alert. See “4.3 Checking the Alerts and Information”.
 Check	Checking the recorded data	Displays the DATA CHECK screen. Checks the connected units to the VDR system. See “4.6 Checking the Recorded Data”.
 Copy	Copying the recorded data	Displays the DATA COPY screen. Copies the recorded data to the USB flash drive. See “4.5 Copying the Recorded Data”.
 Setup	System setup	Displays the SETUP screen. Checks the VDR system settings and Information. See “4.7 System Setup”.
 Gyro I/F	Initial setting of the heading angle	Displays the GYRO I/F screen. Sets the initial heading angle. See “4.8 Initial Setting of the Heading Angle”.



Figure 4-9 Screen transition from the HOME screen

4. Accident countermeasure guidance

If a maritime accident occurred, tap the [Save] button to protect the recorded data. See “4.9 Actions to Take in the Event of an Accident”.

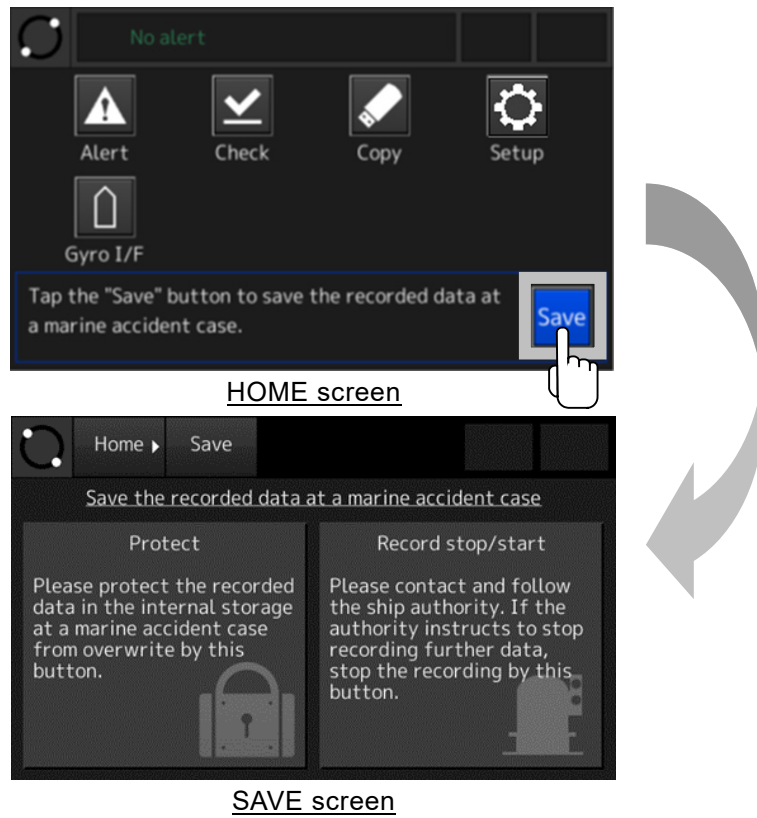

Figure 4-10 SAVE screen

4.3 Checking the Alerts and Information

OPU displays two types of notifications.

- Alert: Abnormal situations and conditions, defined in IEC62923.
- Information: Situations and conditions that are not alerts but need checking.

4.3.1 Definition of alerts

In IEC62923, priority and category of alerts are defined as shown in Table 4-3 and Table 4-4.

Table 4-3 Alert priority defined in IEC62923

Priority	Description	Indication
Emergency alarm	alarm which indicates immediate danger to human life or to the ship and its machinery exists and requires immediate action	Visual presentation and audible signal
Alarm	condition requiring immediate attention and action by the bridge team, to maintain the safe navigation and safe operation of the ship	Visual presentation and audible signal
Warning	condition requiring immediate attention, but no immediate action by the bridge team	Visual presentation and audible signal
Caution	awareness of a condition which does not warrant an alarm or warning condition, but still requires attention out of the ordinary consideration of the situation or of given information	Visual presentation only, no audible signal

Table 4-4 Alert category defined in IEC62923

Category	Description
A	alert for which graphical information at the task station directly assigned to the function generating the alert is necessary, as decision support for the evaluation of the alert related condition
B	alert where no additional information for decision support is necessary besides the information which can be presented at the central alert management HMI
C	alert that cannot be acknowledged on the bridge but for which information is required about the status and treatment of the alert

[NOTE]

According to the definition in IEC62923, all alerts of this equipment are assigned to priority "Caution" and category "B". When new alert occurs, according to the definition of caution alert, that alert is displayed automatically on the OPU but no audible signal occurs.

4.3.2 Notification of alerts and information

The number of active alerts and information are displayed on the Notification button at the top right of the screen.

In addition, newest alert title is displayed at the top of the HOME screen.

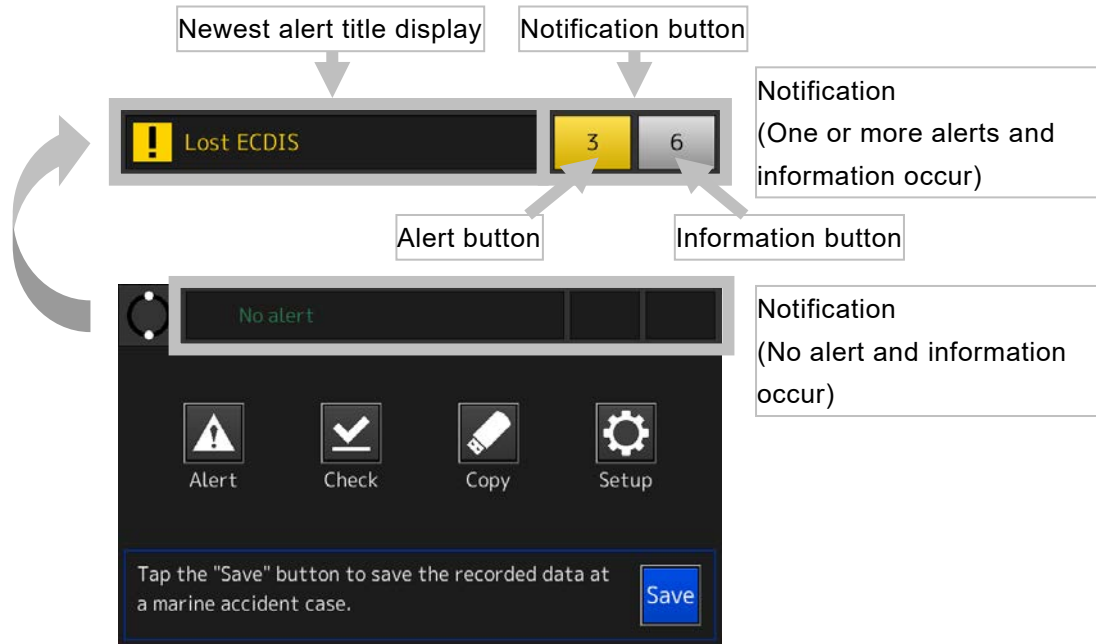

Figure 4-11 Alert and Information notification

Table 4-5 Alert and Information notification

Function	Description
Newest alert title display	Displays the newest alert title. When no alert occurs, "No alert" is displayed.
Notification button	Displays the number of active alerts or information. Notification dialog box is displayed by tapping the notification button.

Detail of alert or information can be checked in notification dialog box. Notification dialog box is displayed in the following case:

The dialog box of alert contents is displayed in the following case:

- When new alert occurs.
- When tapping the notification button.

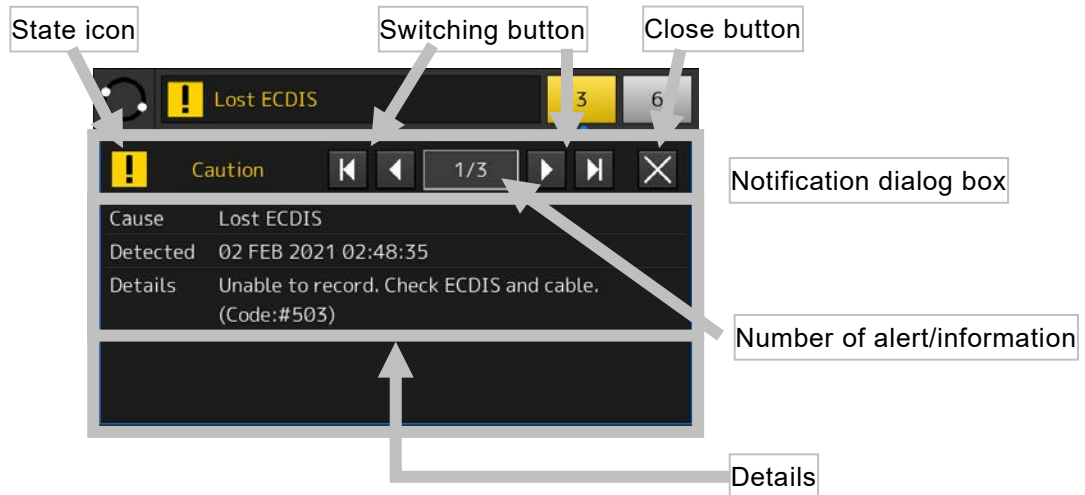



Figure 4-12 Notification dialog box

Table 4-6 Notification dialog box

Function	Description
State icon	Alert:  (Icon for “Caution” priority alert defined in IEC62923) Information: 
Switching button	Switches the displaying notification.
Number of alert/information	[Current displaying notification number] / [Total number of notifications]
Close button	Closes the dialog box.
Details	- Title: Title of the alert/information. - Detected: Date and time that the alert/information occurred. - Details: Description of the alert/information.

4.3.3 When new alert occurs

1. When new alert occurs, notification dialog box is displayed automatically.

[Information]

Automatically displaying is only for new alert. For new information, notification dialog box is not displayed automatically.

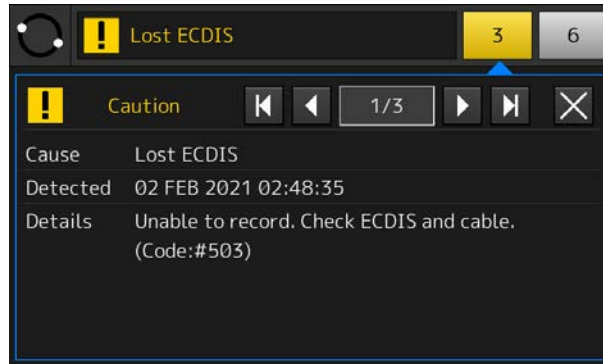

Figure 4-13 When new alert is occurred

2. Check the contents of the alert.

Check the details of the alert and actions to take.

3. Rectify the cause of the alert.

See also “6.3 Troubleshooting”, rectify the cause of the alert. When the cause of the alert is rectified, notification dialog box of the alert is closed automatically and displaying number of alerts is decremented.

4.4 Displaying the Alert List - [Alert] Button

In the ALERT screen, the list of active alerts is displayed.

1. Tap the [Alert] button in the HOME screen.

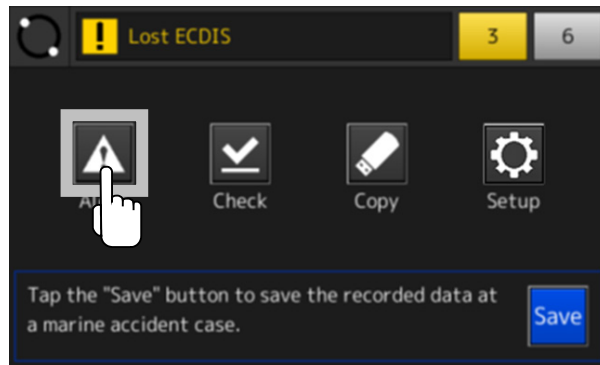

HOME screen



ALERT screen

Figure 4-14 ALERT screen

[Information]

The list is arranged in order of occurrence. The newest alert is displayed at the top of the list.

2. Detail of the alert is displayed by tapping the list item.

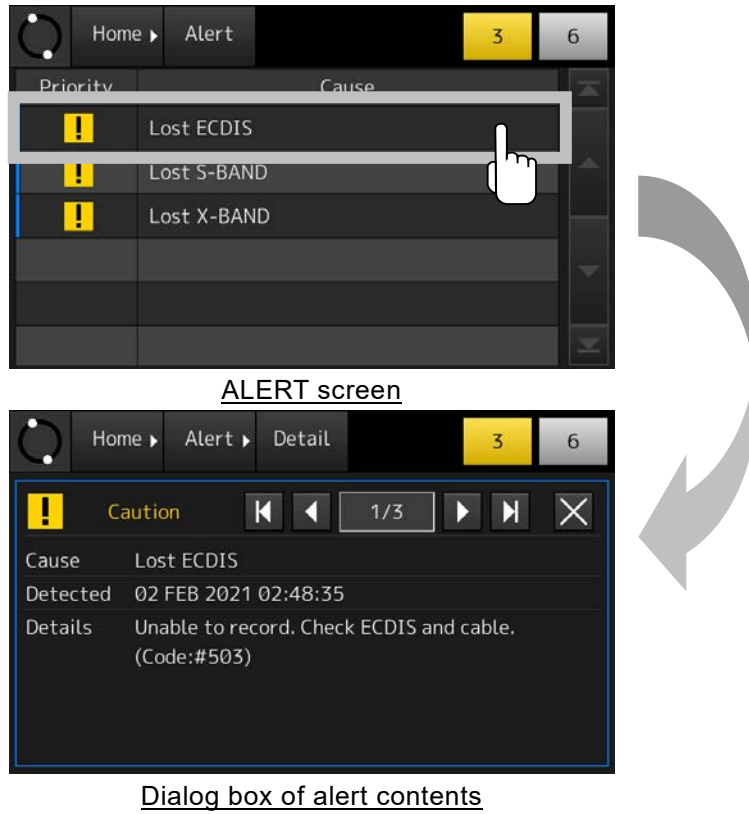

Figure 4-15 Alert details display screen

[Information]

The displayed contents of the alert are the same as that of the notification dialog box.

4.5 Copying the Recorded Data - [Copy] Button

The preserved data by the PROTECT operation and the recorded data in the internal storage can copy to the USB flash drive for up to 6 hours.

[Information]

The recorded data cannot copy to the secure USB flash drives and the USB card reader.

1. Tap the [Copy] button in the HOME screen.

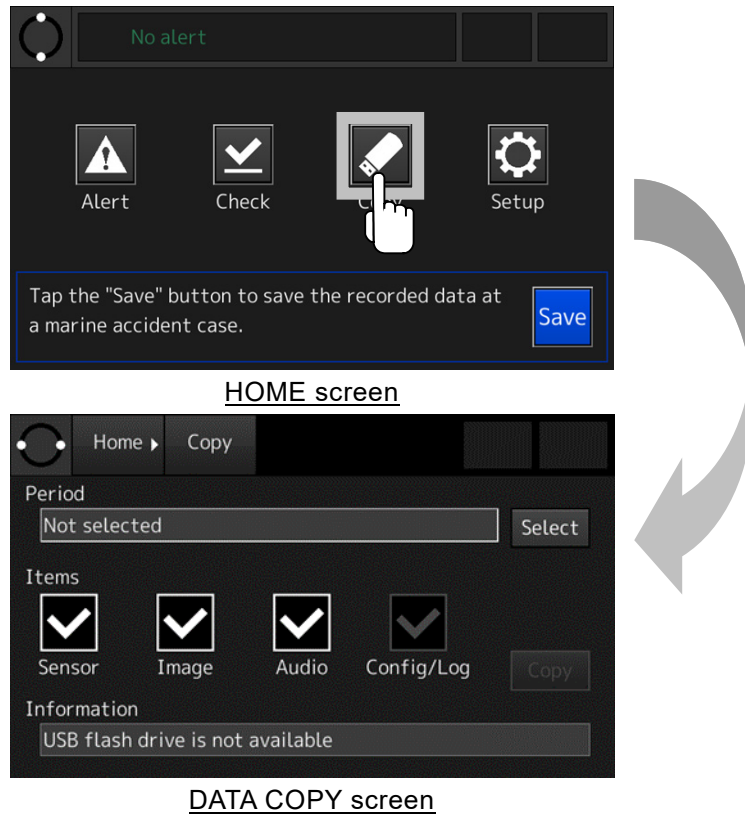

Figure 4-16 COPY screen

2. Remove the OPU's USB port cover and insert the USB flash drive into the USB port.



Figure 4-17 OPU's USB port

[Information]

Use the USB flash drive which formatted as FAT32. The storage capacities can use up to 32GB.

3. Tap the [Select] button in the DATA COPY screen.



Figure 4-18 DATA SELECT screen

4. Tap the [Select] button in the DATA SELECT screen and select from the drop-down list the recorded data that would like to copy.

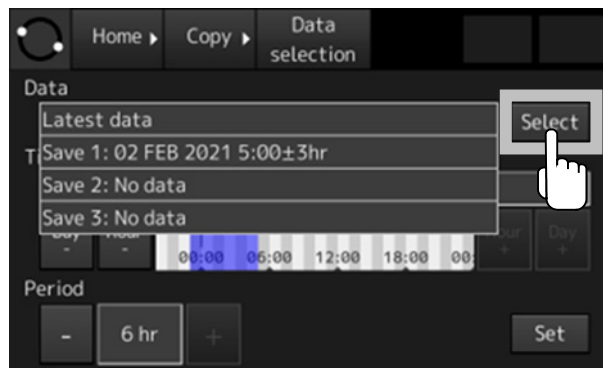

Figure 4-19 Selecting recorded data

Table 4-7 Selectable recorded data

Data name	Description
Latest data	The latest recorded data for 6 hours that is recorded in the internal storage.
Save 1	The preserved data by the PROTECT operation.
Save 2	See “4.9 Actions to Take in the Event of an Accident”.
Save 3	

5. If [Latest data] is selected, change the date and time of recorded data that would like to copy by the button shown in Table 4-8.

The date and time of recorded data that would like to copy

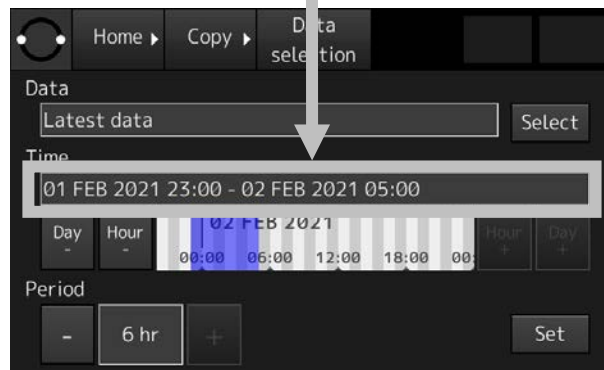

Figure 4-20 Setting the date and time of recorded data

In Figure 4-20, selects the recorded data for six hours from 23:00 on February 1, 2021 to 5:00 on February 2, 2021.

Table 4-8 Button in the DATA SELECT screen

Button	Function
Day -	Changes the date of recorded data that would like to copy. [The center of cursor] minus [one day].
Day +	Changes the date of recorded data that would like to copy. [The center of cursor] plus [one day].
Hour -	Changes hour the hour of recorded data that would like to copy. [The center of cursor] minus [one hour].
Hour +	Changes hour the date of recorded data that would like to copy. [The center of cursor] plus [one hour].
-	Changes the period of copy. [The period of copy] minus [one hour].
6 hr	Displays the period of copy. The settable period of copy is 1 to 6 hours by 1 hour unit.
+	Changes the period of copy. [The period of copy] plus [one hour].

6. Tap the [Set] button in the DATA SELECT screen. Returns to the DATA COPY screen and displays the date and time that would like to copy in the [Period] field.



Figure 4-21 Deciding date and time of recorded data

7. Select the item that would like to copy in the DATA COPY screen. The selectable item is [Sensor], [Image], and [Audio]. Defaults to copying all items. The item not to copy taps the check box, remove the check mark.

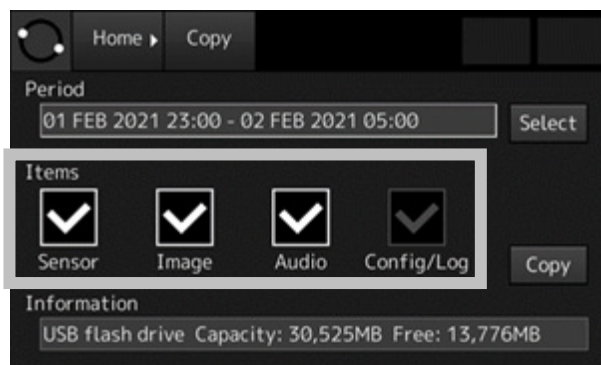

Figure 4-22 Selecting item that would like to copy

8. Tap the [Copy] button in the DATA COPY screen, then starts copying.

If the data starts to be copied, the progress bar is displayed. During copying, the [Copy] button turns into the [Cancel] button. Tapping the [Cancel] button, stops a copy.

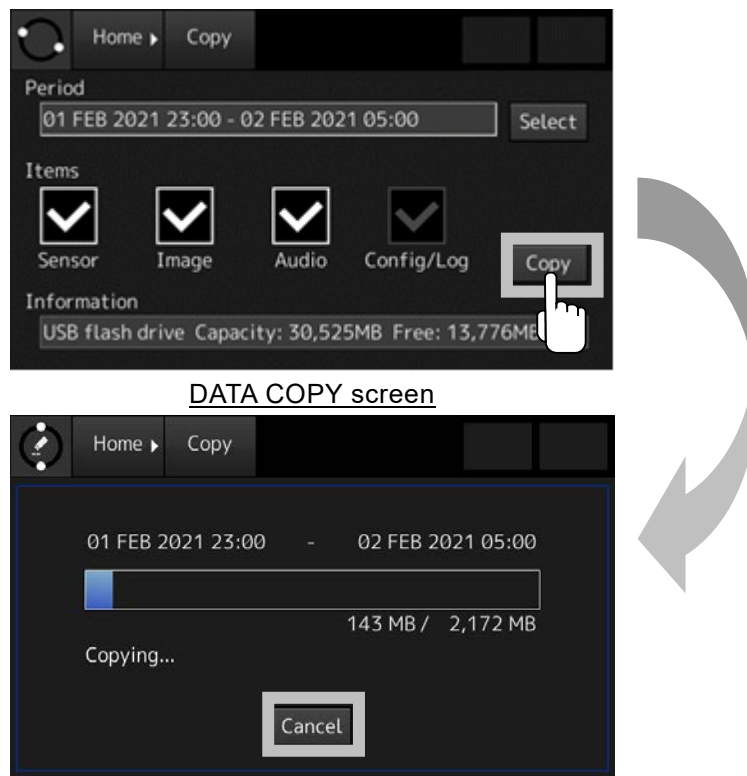

Figure 4-23 Copy operation

[Information]

It takes about 1 hour that to copy the recorded data for 6 hours.

4.6 Checking the Recorded Data - [Check] Button

The recorded data in the VDR system can check in the DATA CHECK screen.

Table 4-9 Recorded data that can check

Item	Description
Sensor	The sensor data of the GPS, the AIS, the gyro and so on.
Image	The image data of the radar, and the ECDIS.
Audio	The audio data of the microphone and VHF communication.
Medium	The recorded time of the FPC, the FFC, and the internal storage.

4.6.1 The DATA CHECK screen

1. Tap the [Check] button in the HOME screen.

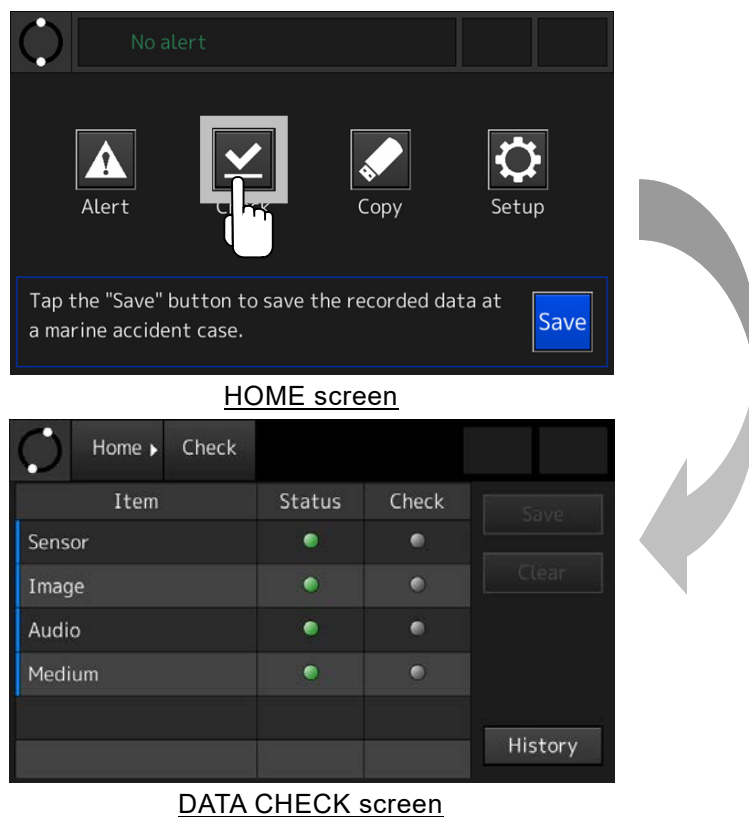

Figure 4-24 DATA CHECK screen

Table 4-10 indicates the items in the DATA CHECK screen.

Table 4-10 Item in DATA CHECK screen

Item	Description
Item	The recorded data that can check.
Status	The status of recorded data.
Check	The judgment result of recorded data by user.

Table 4-11 indicates the indications in the DATA CHECK screen.

Table 4-11 Indication in DATA CHECK screen









Indication	Color	[Status] field	[Check] field
	Green	Normal operation	Normal judgment. All items judged the [Good].
	Yellow	Abnormal operation	There is the non-judgment item.
	Red	—	Abnormal judgment. There is the item that judged the [Fail].
	Gray	—	Under a judgment, or non-judgment.

Table 4-12 indicates the buttons in the DATA CHECK screen.

Table 4-12 Button in DATA CHECK screen

Button	Function
	Saves the judgment result.
	Deletes the judgment result. If the judgment result is deleted, the indication of the [Check] field returns to  (Gray).
	Displays the history of the judgment result.

4.6.2 Checking the sensor data

1. Tap the [Sensor] field in the DATA CHECK screen.

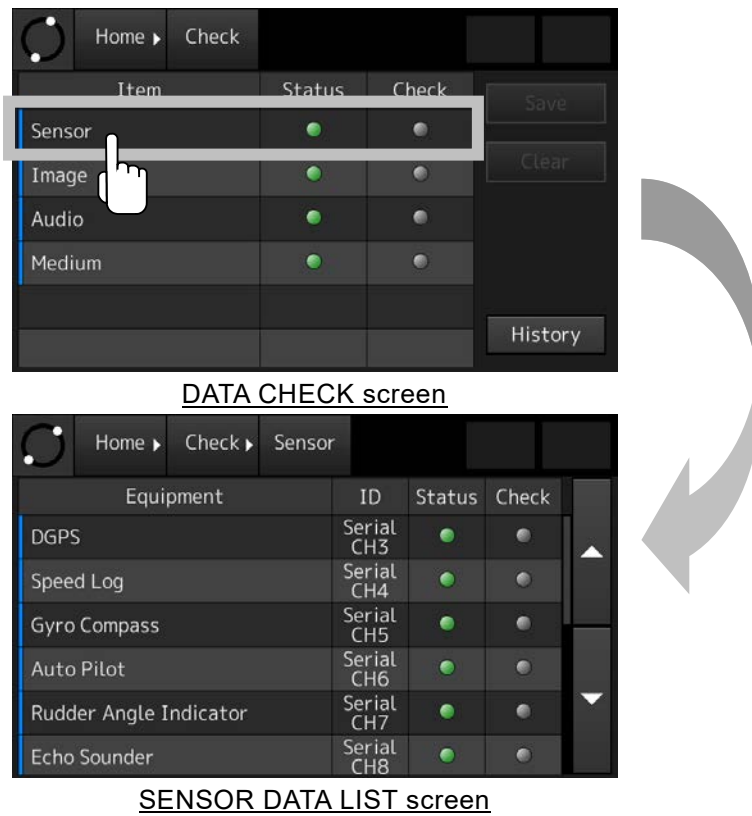

Figure 4-25 SENSOR DATA LIST screen

Table 4-13 indicates the items in the SENSOR DATA LIST screen.

Table 4-13 Item in SENSOR DATA LIST screen

Item	Description
Equipment	The equipment name.
ID	The interface and the identification code.
Status	The status of recorded data.
Check	The judgment result of recorded data by user.

Table 4-14 indicates the indications in the SENSOR DATA LIST screen.

Table 4-14 Indication in SENSOR DATA LIST screen

Indication	Color	Status	Check
	Green	Normal operation	Normal judgment. The item judged the [Good].
	Yellow	Abnormal operation	—
	Red	—	Abnormal judgment. The item judged the [Fail].
	Gray	—	Under a judgment, or non-judgment.

2. Tap the equipment field that would like to check.

Equipment	ID	Status	Check
DGPS	Serial CH3	●	●
Speed Log	Serial CH4	●	●
Gyro Compass	Serial CH5	●	●
Auto Pilot	Serial CH6	●	●
Rudder Angle Indicator	Serial CH7	●	●
Echo Sounder	Serial CH8	●	●

SENSOR DATA LIST screen

DGPS		Good	Fail
Status	Communication within 1 minute		
DTM:	Datum		
	Local geodetic datum: WGS84		
ZDA:	Date and time		
	UTC: 02 FEB 2021 04:11:23.53		
GGA:	Ship's position		
	Latitude: 35°41.0000' N		
	Longitude: 139°34.0000' E		

SENSOR DATA CHECK screen

Figure 4-26 SENSOR DATA CHECK screen

3. Check that the sensor data are received normally.

[Good] button [Fail] button

Displays the presence of the communication within 1 minute

[Up] button

[Down] button

Displays the received sensor data

Figure 4-27 SENSOR DATA CHECK screen

4. The [Check] field displays the judgement result.

Equipment	ID	Status	Check
DGPS	Serial CH3	<input checked="" type="radio"/>	<input type="radio"/>
Speed Log	Serial CH4	<input checked="" type="radio"/>	<input type="radio"/>
Gyro Compass	Serial CH5	<input checked="" type="radio"/>	<input type="radio"/>
Auto Pilot	Serial CH6	<input checked="" type="radio"/>	<input type="radio"/>
Rudder Angle Indicator	Serial CH7	<input checked="" type="radio"/>	<input type="radio"/>
Echo Sounder	Serial CH8	<input checked="" type="radio"/>	<input type="radio"/>

SENSOR DATA LIST screen

Figure 4-28 SENSOR judgment result

5. For all registered equipment in the list, conduct from Step 2 to Step 4.

4.6.3 Checking the image data

1. Tap the [Image] field in the DATA CHECK screen

Item	Status	Check
Sensor	<input checked="" type="radio"/>	<input type="radio"/>
Image	<input checked="" type="radio"/>	<input type="radio"/>
Audio	<input checked="" type="radio"/>	<input type="radio"/>
Medium	<input checked="" type="radio"/>	<input type="radio"/>

DATA CHECK screen

Equipment	ID	Status	Check
JMR-9225X	D1	<input checked="" type="radio"/>	<input type="radio"/>
JMR-9230S	D2	<input checked="" type="radio"/>	<input type="radio"/>
JAN-9201	D3	<input checked="" type="radio"/>	<input type="radio"/>
JAN-9201	D4	<input checked="" type="radio"/>	<input type="radio"/>
JMR-7225X	D5	<input checked="" type="radio"/>	<input type="radio"/>
JAN-7201	D6	<input checked="" type="radio"/>	<input type="radio"/>

IMAGE DATA LIST screen

Figure 4-29 IMAGE screen





Table 4-15 indicates the items in the IMAGE DATA LIST screen.

Table 4-15 Item in IMAGE DATA LIST screen

Item	Description
Equipment	The equipment name.
ID	The identification code: R*: Radar E*: ECDIS D*: Multi function display
Status	The status of recorded data.
Check	The judgment result of recorded data by user.

Table 4-16 indicates the indications in the IMAGE DATA LIST screen.

Table 4-16 Indication in IMAGE DATA LIST screen

Indication	Color	Status	Check
	Green	Normal operation	Normal judgment. The item judged the [Good].
	Yellow	Abnormal operation	—
	Red	—	Abnormal judgment. The item judged the [Fail].
	Gray	—	Under a judgment, or non-judgment.

2. Tap the equipment that would like to check.

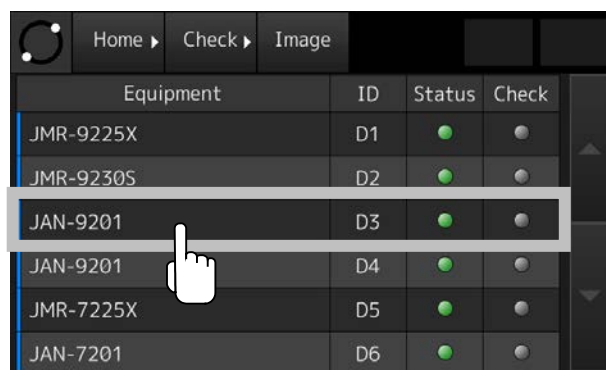

IMAGE DATA LIST screen

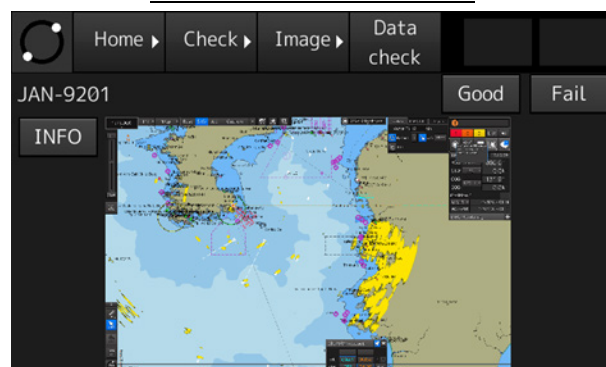

IMAGE DATA CHECK screen

Figure 4-30 IMAGE DATA CHECK screen

3. Check that the image data is received normally.

If the image data is received normally, tap the [Good] button. If the image data cannot receive, tap the [Fail] button. Tapping the [Good] button or the [Fail] button, returns to the IMAGE DATA LIST screen.

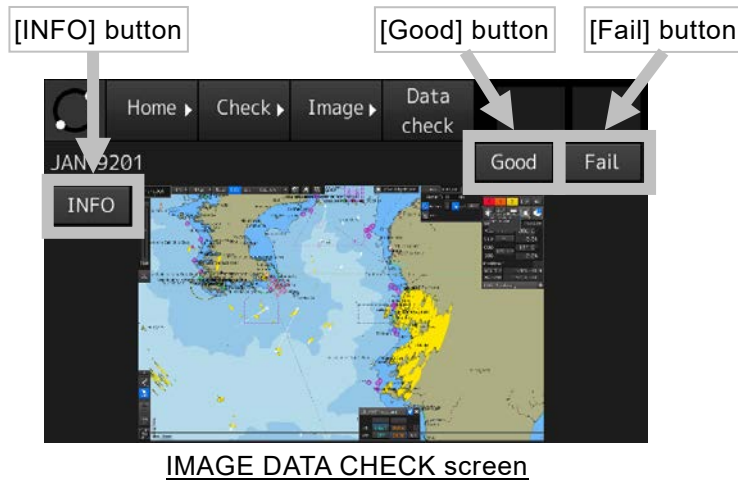

Figure 4-31 IMAGE DATA CHECK screen

[Information]

The displayed image data can enlarge tapped part. Tapping the screen again, then displayed image data returns to the original size.

4. In the ECDIS, check that the chart information is received normally.

Tap the [INFO] button in the IMAGE DATA CHECK screen. Then the chart information is displayed. Tapping the [Image] button in the CHART INFORMATION CHECK screen, returns to the IMAGE DATA CHECK screen. If the chart information cannot receive, it is displayed with “No information”.

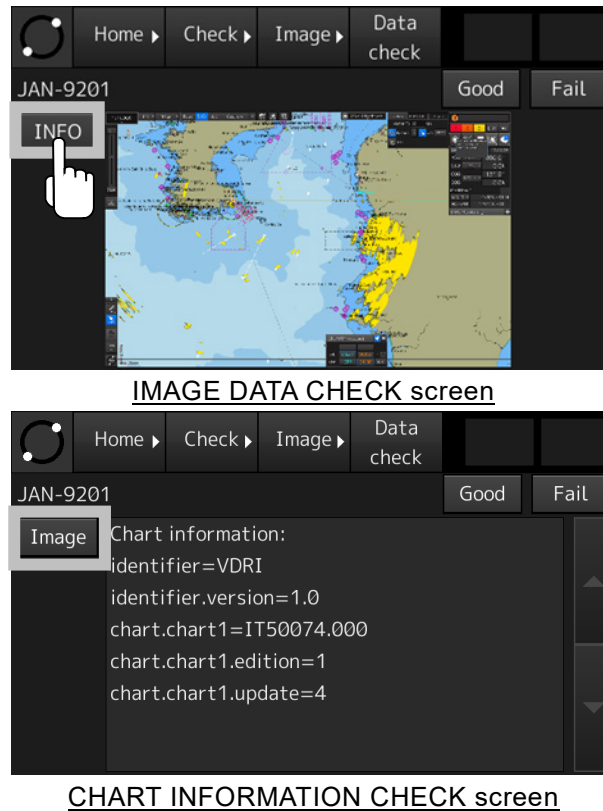

Figure 4-32 CHART INFORMATION CHECK screen

5. The [Check] field displays the judgment result.

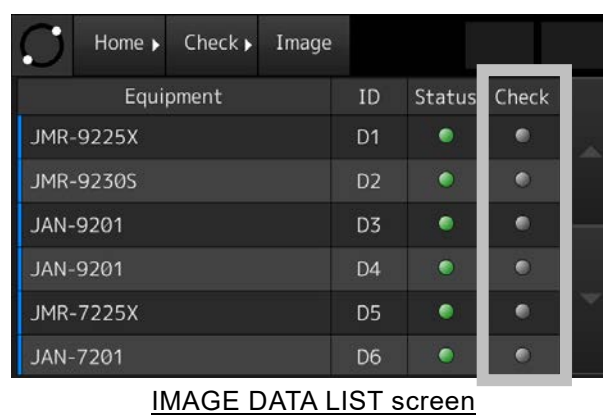

Figure 4-33 IMAGE judgment result

6. For all registered equipment in the list, conduct from Step 2 to Step 4.

4.6.4 Checking the audio data

1. Tap the [Audio] field in the DATA CHECK screen.

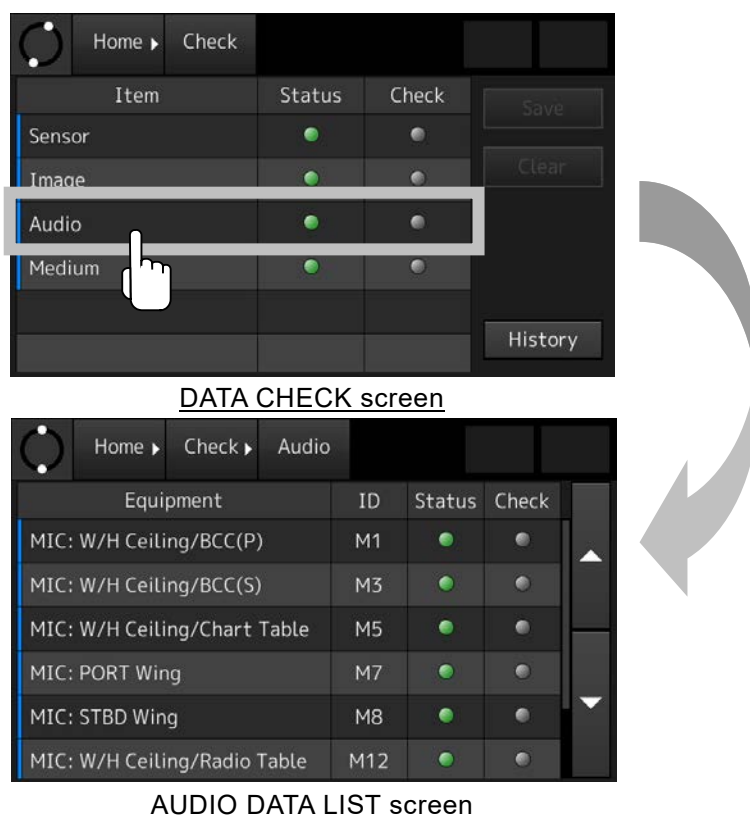

Figure 4-34 AUDIO DATA LIST screen





Table 4-17 indicates the items in the AUDIO DATA LIST screen.

Table 4-17 Item in AUDIO DATA LIST screen

Item	Description
Equipment	The equipment name or the installation location.
ID	The identification code.
Status	The result of self-diagnosis that performed every 12 hours.
Check	The judgment result of recorded data by user.

Table 4-18 indicates the indications in the AUDIO DATA LIST screen.

Table 4-18 Indication in AUDIO DATA LIST screen

Indication	Color	Status	Check
	Green	Normal operation	Normal judgment. All items judged the [Good].
	Yellow	Abnormal operation	There is the non-judgment item.
	Red	—	Abnormal judgment. There is the item that judged the [Fail].
	Gray	—	Before performing the self-diagnosis test.

2. Tap the equipment that would like to check.

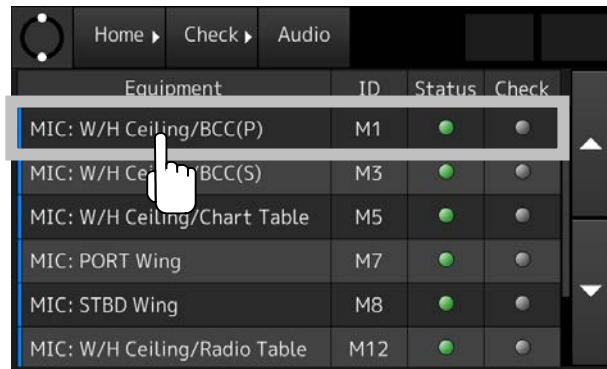

Equipment	ID	Status	Check
MIC: W/H Ceiling/BCC(P)	M1	●	●
MIC: W/H Ceiling/BCC(S)	M3	●	●
MIC: W/H Ceiling/Chart Table	M5	●	●
MIC: PORT Wing	M7	●	●
MIC: STBD Wing	M8	●	●
MIC: W/H Ceiling/Radio Table	M12	●	●

AUDIO DATA LIST screen

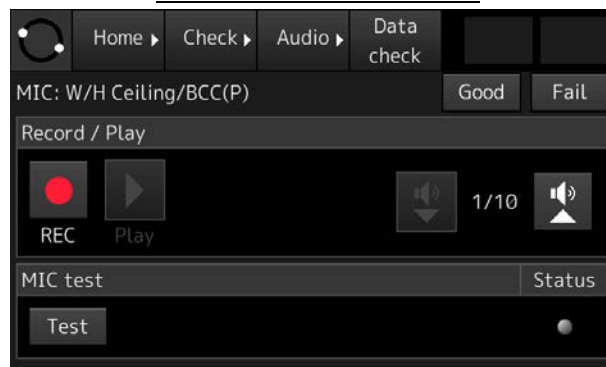

AUDIO DATA CHECK screen

Figure 4-35 AUDIO DATA CHECK screen

3. Records the conversation of the bridge, the wings, and the VHF radio communication. Then, plays back those audio data.

1) Tap the [REC] button. Then the recording starts.

During the recording, the recording time is displayed with the display of “Recording”. If the recording time passes 1 minute, the recording stops automatically.

2) Tap the [Stop] button. Then the recording stops.

After the recording stops, the recording time is displayed.

3) Tap the [Play] button. Then the recorded audio plays back.

During the playback, the playing time is displayed with the display of “Playing”. If the playback time passes the recording time, the playback stops automatically.

4) Tap the [Stop] button. Then the playback stops.

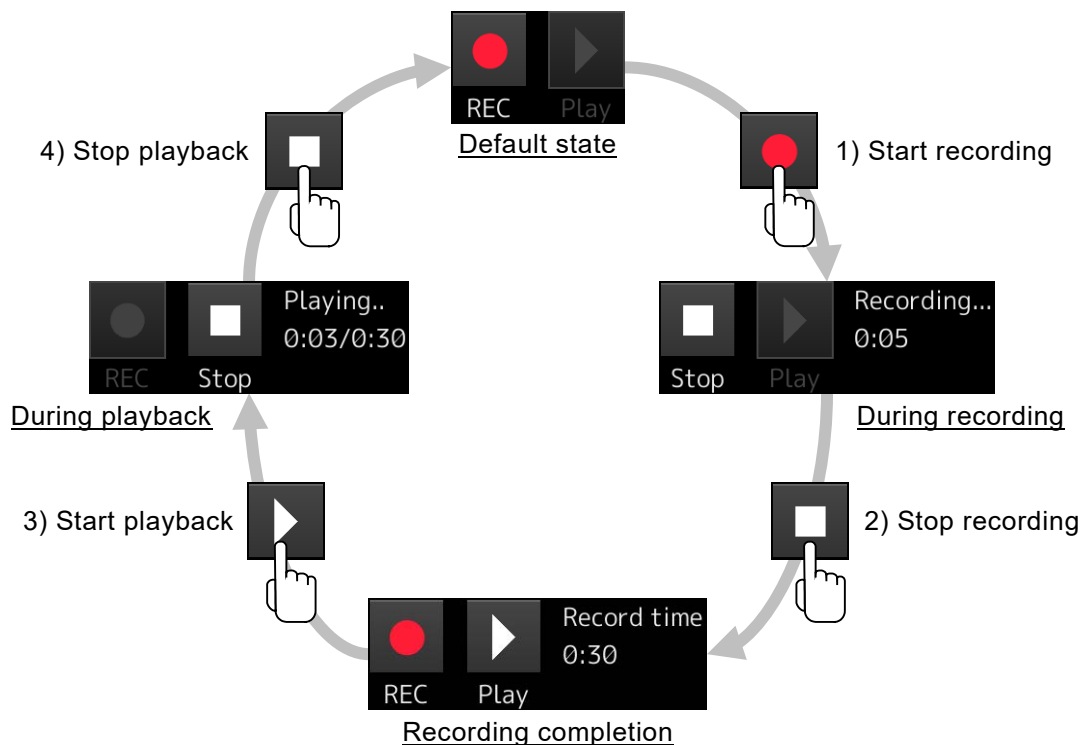





Figure 4-36 Sequence for recording and playback

Table 4-19 Volume control

Button	Function
	Turns down the volume of playback.
	Turns up the volume of playback.
	Indicates the current volume. The range of volume adjustment is “1” to “10”. The “1” is a minimum volume and the “10” is a maximum volume.

[Information]

The OPU cannot mute the volume of playback.



4. Conducts the self-diagnosis test of the microphone.

[Information]

The self-diagnosis test is function only for the microphone.

- 1) Tap the [Test] button in the AUDIO DATA CHECK screen. Then the self-diagnosis test starts.
- 2) After approximately 1 minute, the result of self-diagnosis test is displayed to the right side of the [Test] button, and the indication of the [Status] field changes.

Table 4-20 Indication of self-diagnosis test

indication	Color	Description	Result
	Green	The self-diagnosis test passed without problem.	Good
	Yellow	The self-diagnosis test failed.	Fail
	Gray	The self-diagnosis test is not conducted.	---

5. Judge with the [Good] button and the [Fail] button from the result of Step 3 and Step 4. If the [Good] button or the [Fail] button taps, returns to the AUDIO DATA LIST screen.

6. For all equipment in the list, conduct from Step 2 to Step 5.

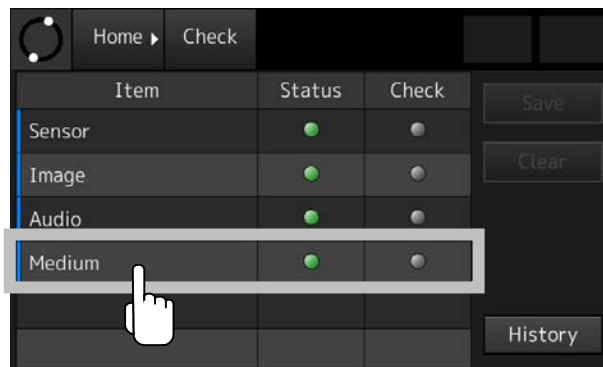
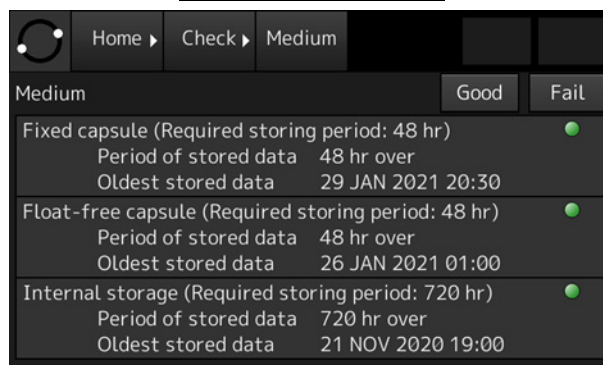

4.6.5 Checking the recording time

1. Tap the [Medium] field in the DATA CHECK screen.

DATA CHECK screenMEDIUM screen**Figure 4-37 MEDIUM screen**

2. Check the recording period of the FPC, the FFC, and the internal storage.

Table 4-21 Indication in MEDIUM screen

Indication	Color	Description
	Green	The Data for the specified length of time or more has been recorded.
	Yellow	Data for the specified length of time is not recorded.
	Gray	The recording period is not measured. After the RCU start, there is the state of non-measurement for 10 minutes.

[Information]

Because the judgment of each medium is conducted automatically, it is not necessary for a user to judge it.

3. Judge from the result of Step 2.

If the judgment results have no problem, tap the [Good] button. If the judgment results have a problem, tap the [Fail] button. Tapping the [Good] button or the [Fail] button, returns to the DATA CHECK screen.

4.6.6 Saving the judgment results

If the judgment is conducted, the [Save] button in the DATA CHECK screen is enabled.

Tap the [Save] button in the DATA CHECK screen. Then the judgment results of the sensor data, the audio data, and the medium are saved. The judgement results are saved to the FPC, the FFC, and the internal storage.

Tap the [Clear] button in the DATA CHECK screen. Then the judgment results that are not saved yet are all cleared.

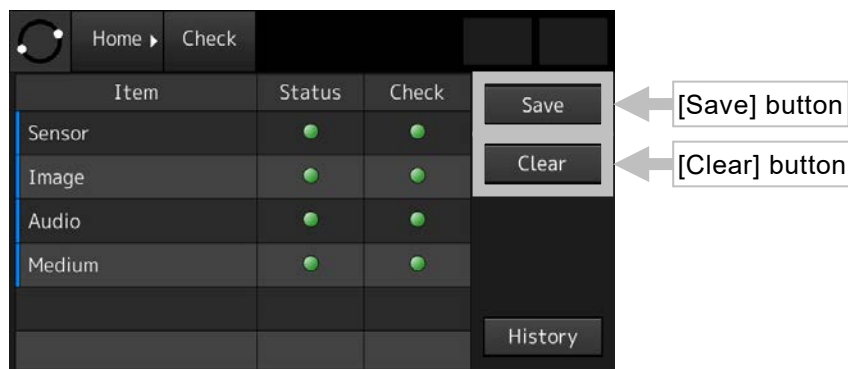

Figure 4-38 DATA CHECK screen

[NOTE]

The [Status] indicator becomes yellow just after the equipment started. Because the recorded time doesn't reach at time necessary for a judgment. If the FPC, the FFC, and the internal storage is replaced, the [Status] indicator becomes yellow.

4.6.7 Displaying the data check history

1. Tap the [History] in the DATA CHECK screen.

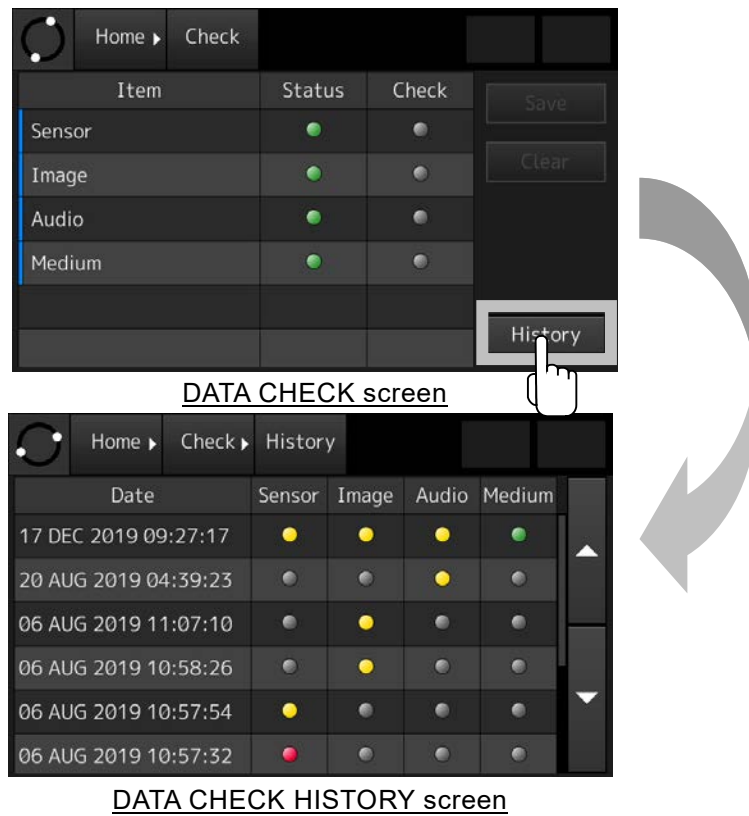





Figure 4-39 DATA CHECK HISTORY screen

Table 4-22 Indication in DATA CHECK HISTORY screen

Indication	Color	Description
	Green	Normal judgment. All items are judged the [Good].
	Yellow	There is the non-judgment item.
	Red	Abnormal judgment. There is the item that is judged the [Fail].
	Gray	Non-judgment.

4.7 System Setup - [Setup] Button

In the SYSTEM SETUP screen, it's possible to change the VDR system settings and check the VDR system information.

4.7.1 The SYSTEM SETUP screen

1. Tapping the [Setup] button, then the SYSTEM SETUP screen is displayed.

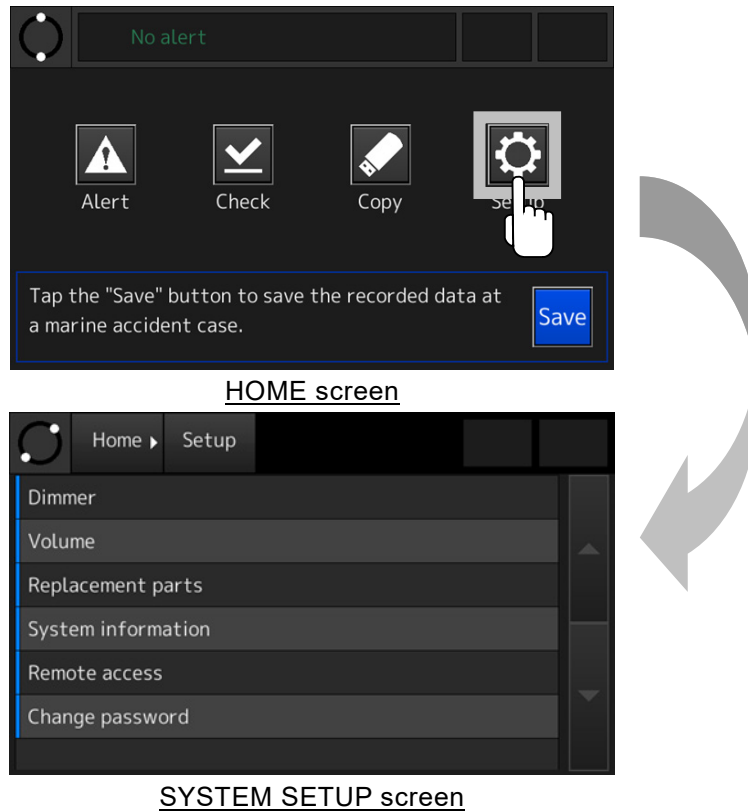

Figure 4-40 SYSTEM SETUP screen

Table 4-23 Item in SYSTEM SETUP screen

Item	Function
Dimmer	Adjusting the screen brightness.
Volume	Adjusting the volume of screen touch sound.
Replacement parts	Checking the replacement parts and the OPU operating hours.
System information	Checking the software version.
Remote access	Controlling the remote access permission.
Change password	Changing the password. The factory default password is "0000".

4.7.2 Adjusting the screen brightness

1. Tap the [Setup] button. The SYSTEM SETUP screen is displayed.

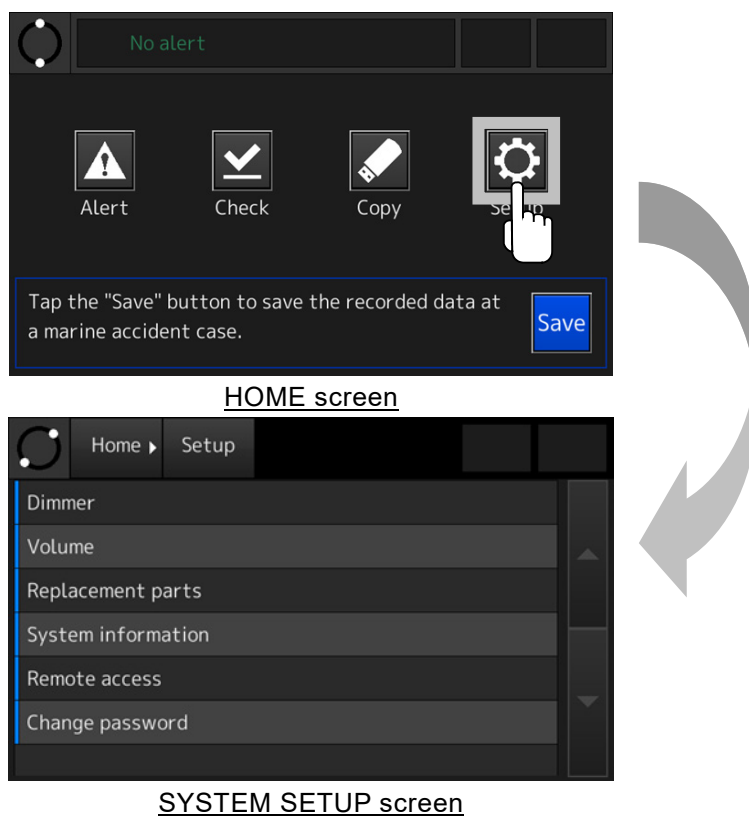

Figure 4-41 SYSTEM SETUP screen

2. Tap the [Dimmer]. The BRIGHTNESS ADJUSTMENT screen is displayed.

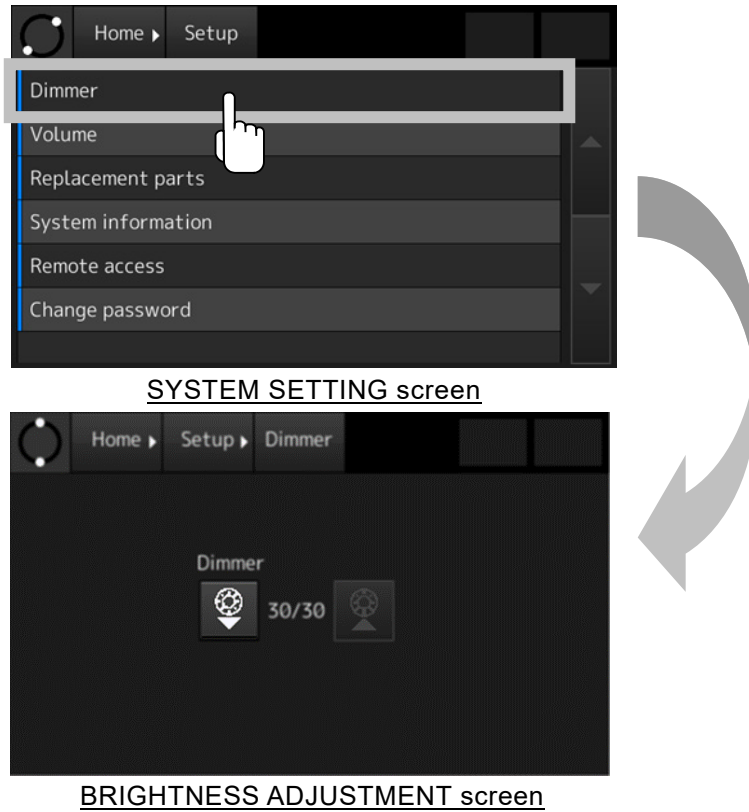





Figure 4-42 BRIGHTNESS ADJUSTMENT screen

3. Adjust the screen brightness by operating the buttons listed in Table 4-24.

Table 4-24 Brightness adjustment button

Button	Function
	Turns down the screen brightness.
	Turns up the screen brightness.
	Indicates the current screen brightness. The range of screen brightness adjustment is "0" to "30". "0" is a minimum brightness and "30" is a maximum brightness.

4.7.3 Adjusting the volume of screen touch sound

1. Tap the [Setup] button. The SYSTEM SETUP screen is displayed.

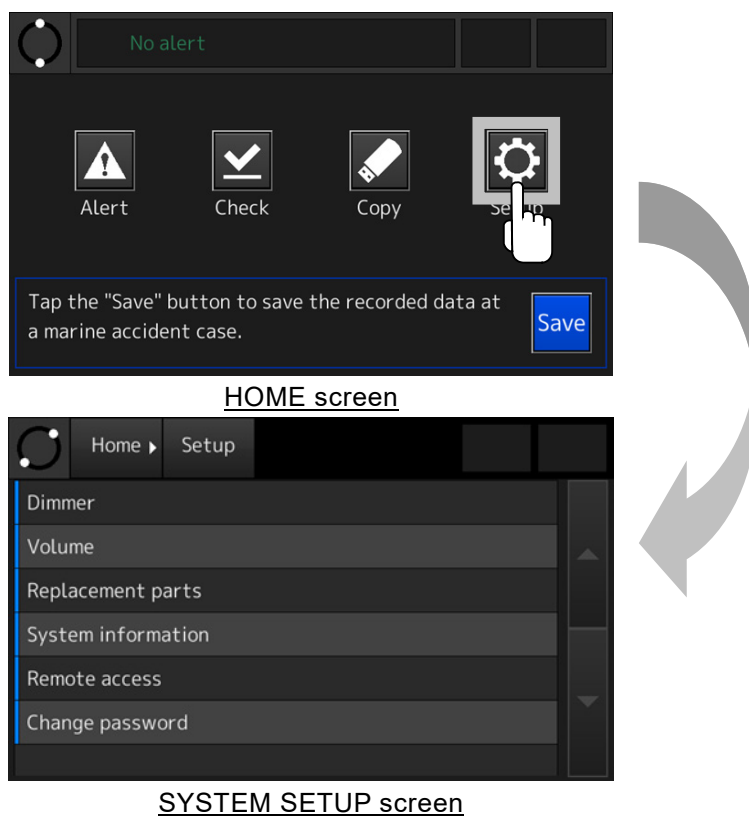

Figure 4-43 SYSTEM SETUP screen

2. Tap the [Volume]. The VOLUME ADJUSTMENT screen is displayed.

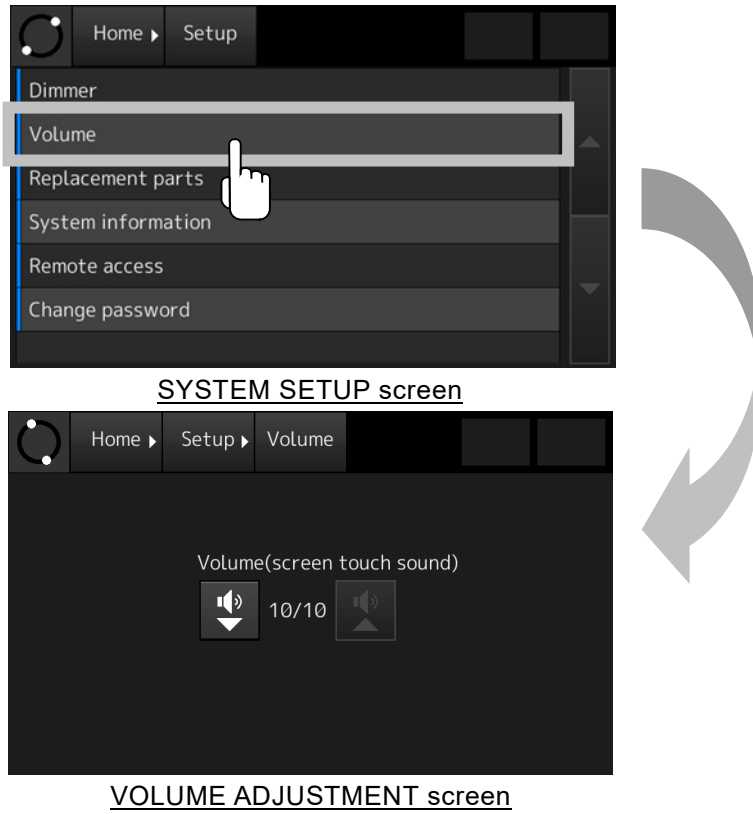





Figure 4-44 VOLUME ADJUSTMENT screen

3. Adjust the volume by operating the button listed in Table 4-25.

Table 4-25 Volume adjustment button

Button	Function
	Turns down the volume of screen touch sound.
	Turns up the volume of screen touch sound.
	Indicates the current volume. The range of volume adjustment is "0" to "10". The "0" is a mute and the "10" is maximum volume.

4.7.4 Checking the replacement parts

1. Tap the [Setup] button. The SYSTEM SETUP screen is displayed.

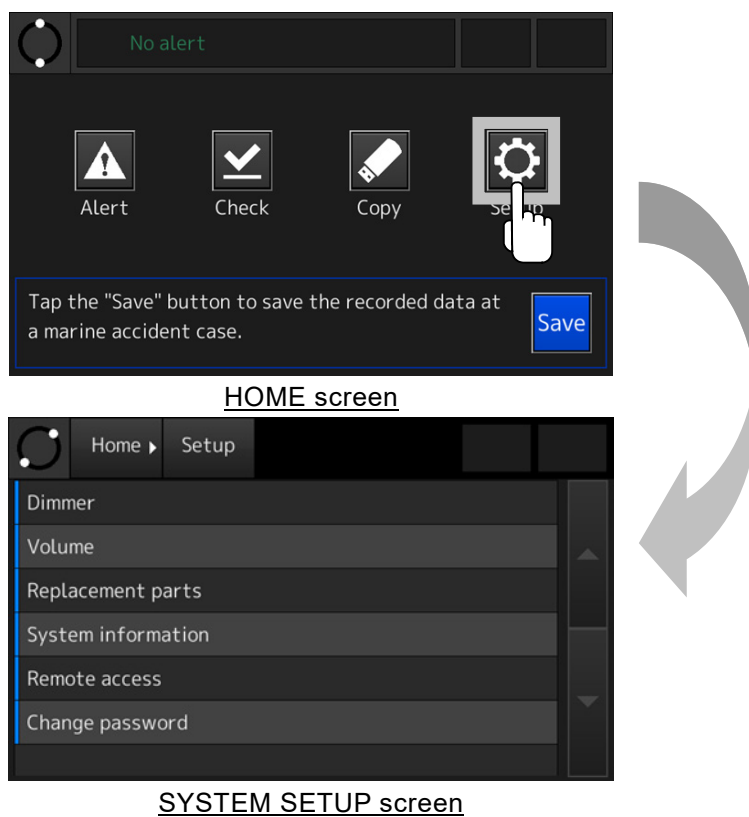

Figure 4-45 SYSTEM SETUP screen

2. Tap the [Replacement parts]. In the REPLACEMENT PARTS screen, it's possible to check the following items:

- The expiration date of the FPC underwater acoustic beacon
- The implementation deadline of the FFC SBM
- The expiration date of the FFC Hydrostatic Release Unit (HRU)
- The expiration date of the RCU built-in battery
- The expiration date of the RCU built-in fan
- The expiration date of the FGU built-in fan
- The operating time of the OPU

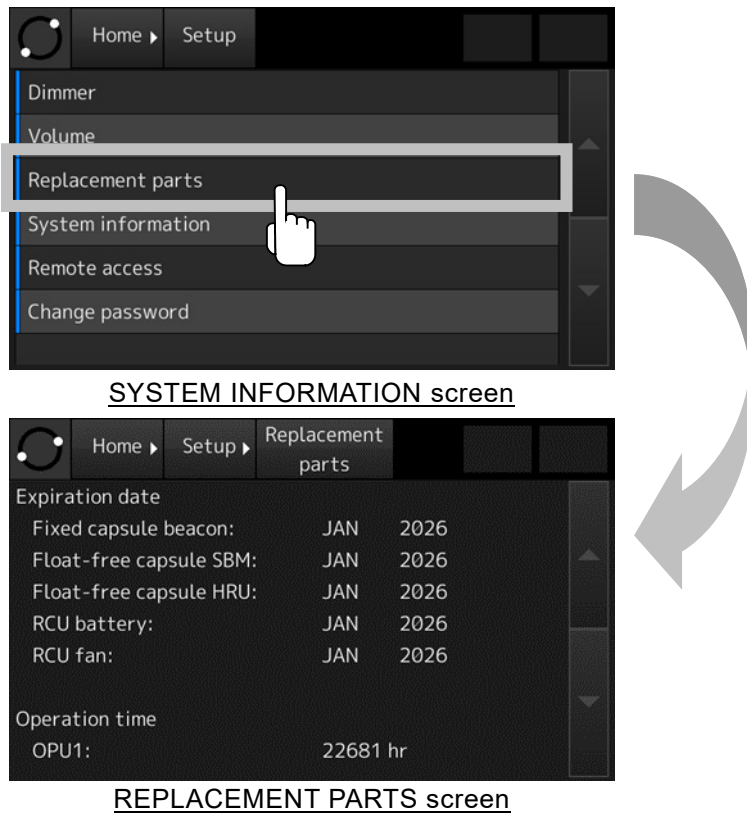

Figure 4-46 REPLACEMENT PARTS screen

[Information]

Items for unequipped parts are not displayed.

4.7.5 Checking the system information

1. Tap the [Setup] button. The SYSTEM SETUP screen is displayed.

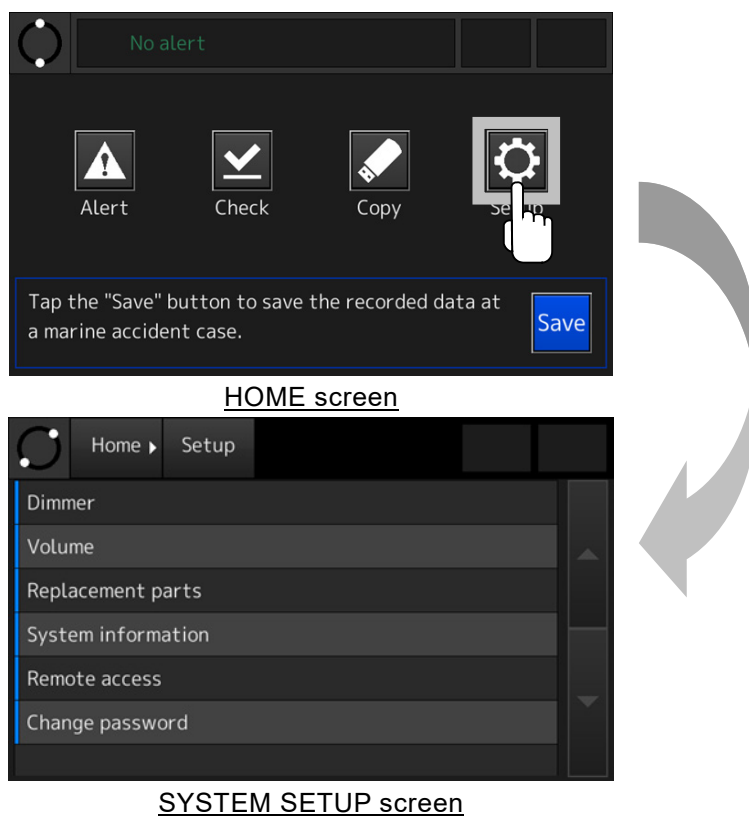

Figure 4-47 SYSTEM SETUP screen

2. Tap the [System information]. In the SYSTEM INFORMATION screen, it's possible to check the software version of the VDR system.

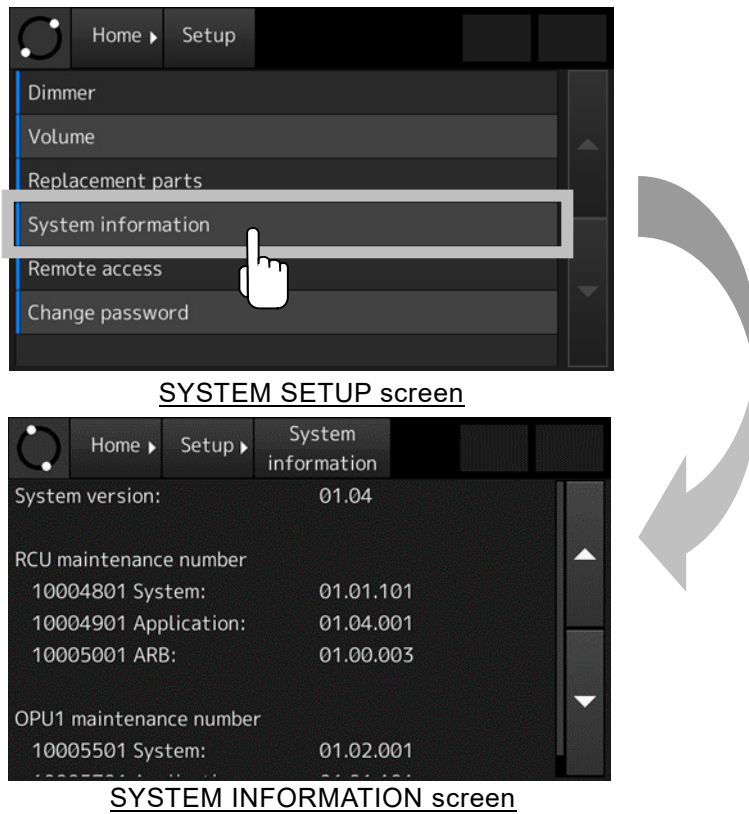

Figure 4-48 SYSTEM INFORMATION screen

4.7.6 Controlling the remote access permission

[Information]

By using the remote access function, VDR maintenance operation can be performed remotely from our shore system. To enable the remote access function, it is necessary to change the VDR settings and connect the VDR to the satellite communication system. For more information, please contact our sales department.

1. Tap the [Setup] button. The SYSTEM SETUP screen is displayed.

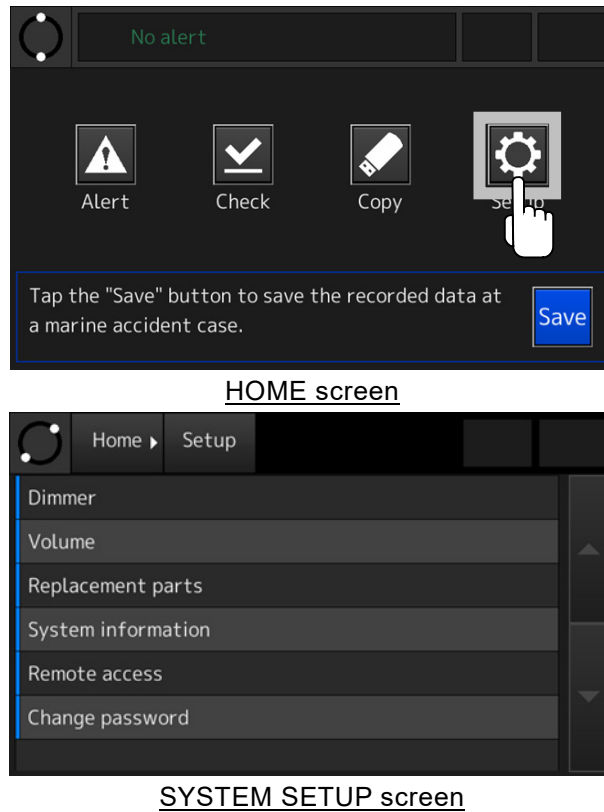
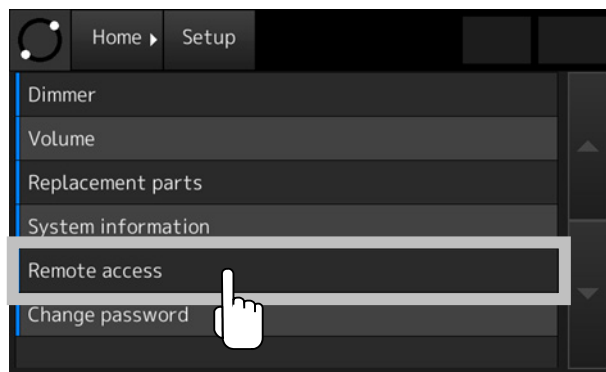
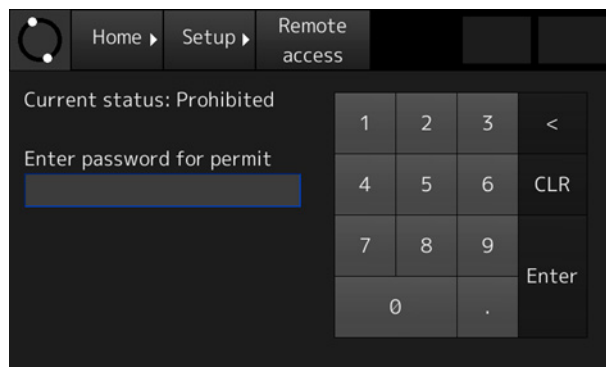

Figure 4-49 SYSTEM SETUP screen

2. Tap the [Remote access]. The REMOTE ACCESS screen is displayed.



SYSTEM SETUP screen



REMOTE ACCESS screen (When prohibited)

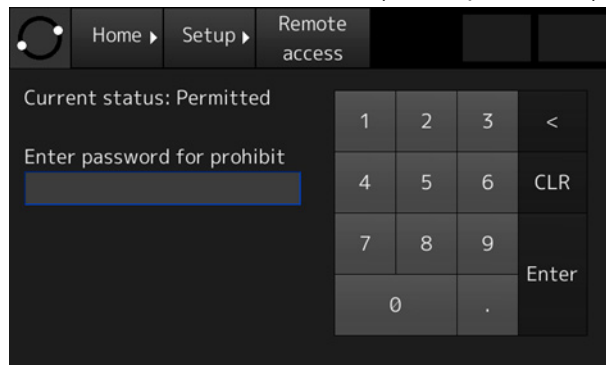

REMOTE ACCESS screen (When permitted)

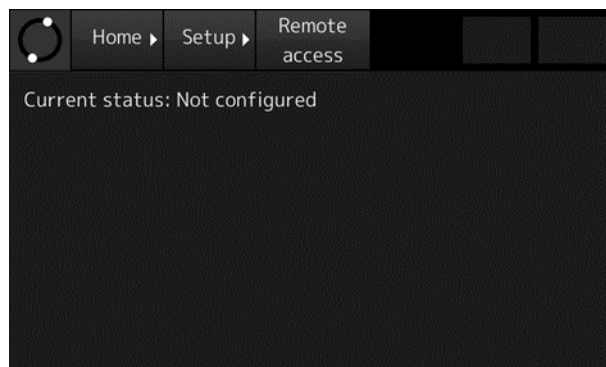

REMOTE ACCESS screen (When not enabled)

Figure 4-50 REMOTE ACCESS screen

3. To permit or prohibit remote access, enter the password and tap the [Enter] button. The permission is changed, and the successful completion message is displayed.

If remote access is prohibited during remote accessing, the connection is disconnected.

[Information]

The factory default password is "0000". Manage the password by the ship administrator. About how to enter a number, see "4.1.5 Number input".

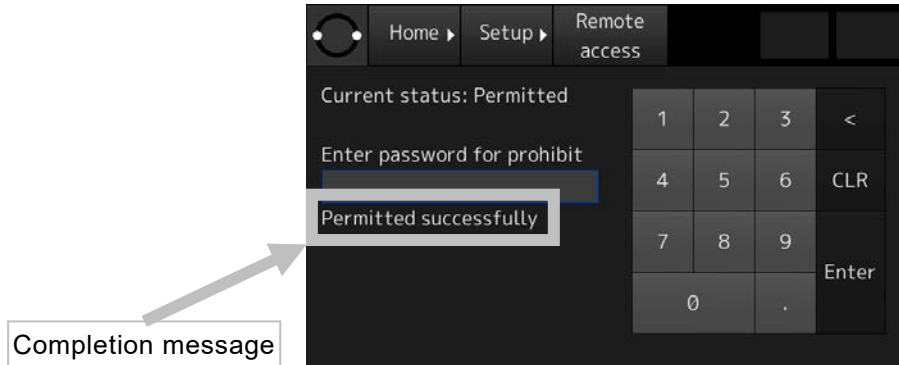

Figure 4-51 Permit remote access

[Information]

If the password is incorrect, the error message is displayed. Enter the password again.

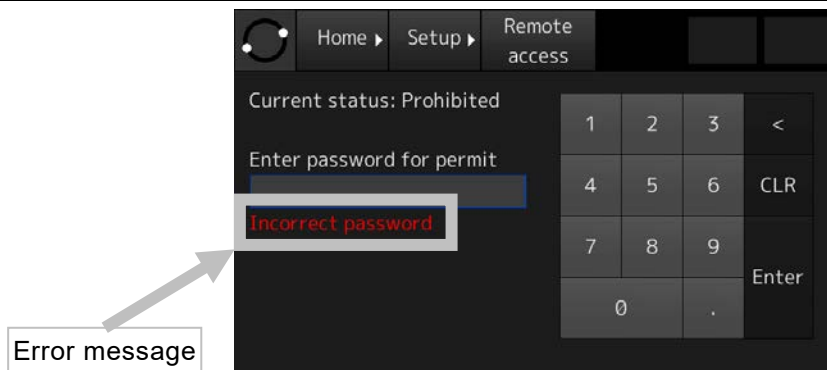

Figure 4-52 Incorrect password error

[Information]

When remote access is permitted and a connection has been established with the shore system, the following information is displayed.

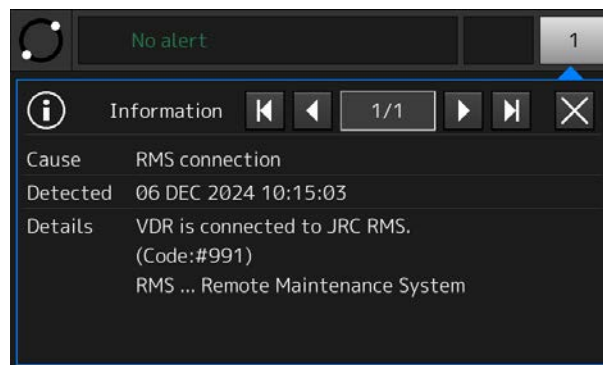

Figure 4-53 Information: RMS connection

4.7.7 Changing the password

1. Tap the [Setup] button. The SYSTEM SETUP screen is displayed.

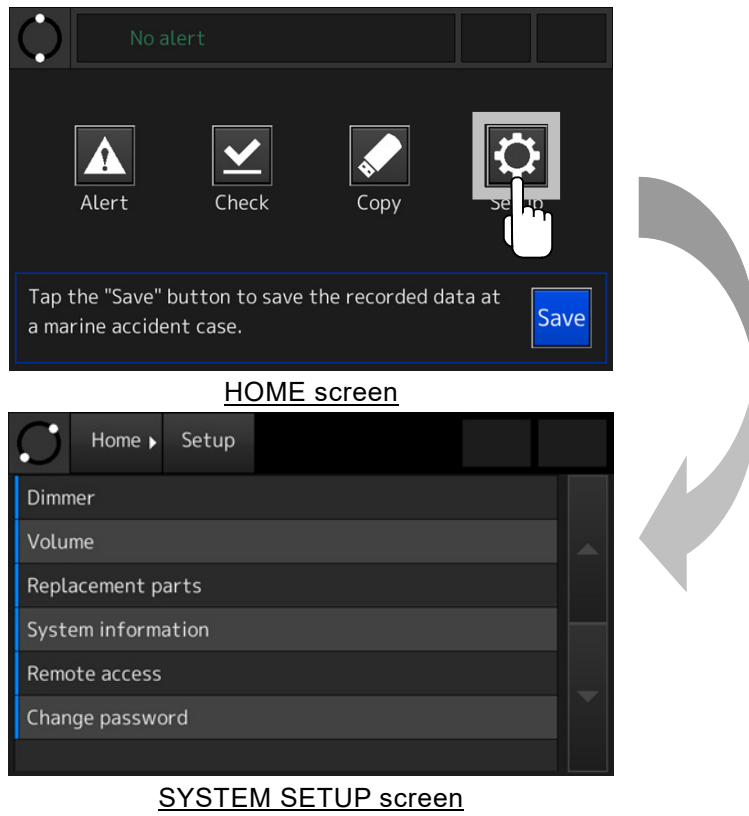

Figure 4-54 SYSTEM SETUP screen

2. Tap the [Change password]. The CHANGE PASSWORD screen is displayed.

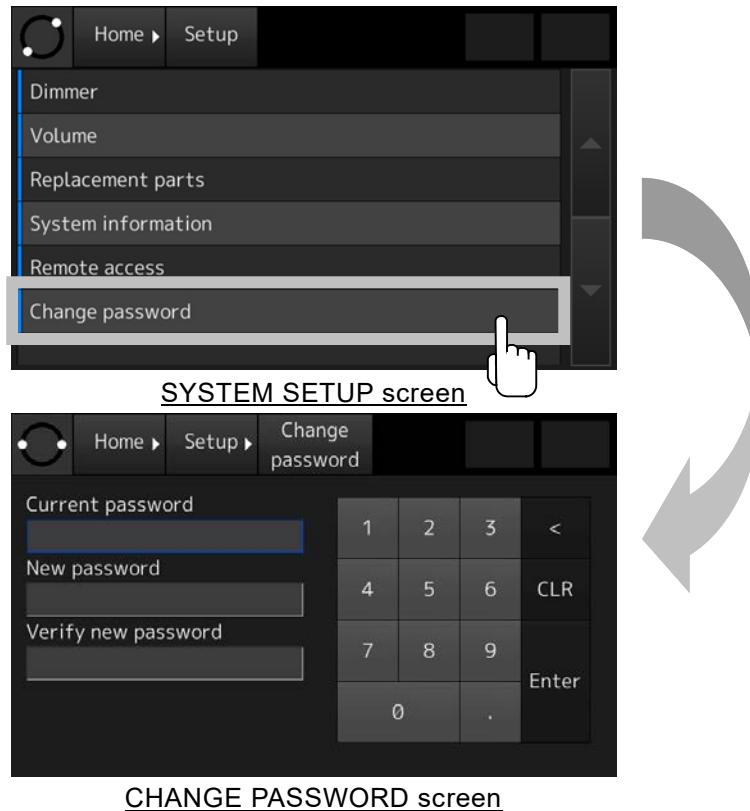

Figure 4-55 CHANGE PASSWORD screen

3. Enter the current password in the [Current Password] field.

[Information]

The factory default password is "0000". Manage the password by the ship administrator. About how to enter a number, see "4.1.5 Number input".

4. After tap the [Enter] button, the cursor moves to the [New password] field.

5. Enter the new password in the [New password] field. The password can enter up to 16 characters.

6. After tap the [Enter] button, the cursor moves to the [Verify new password] field.

7. To verify the password, enter the new password again.

[NOTE]

Do not forget the changed password. If the password is forgotten, contact our head office, or a nearby branch or local office to request servicing.

4.8 Initial Setting of the Heading Angle - [Gyro I/F] Button

If the ship's heading angle data input the synchronous or step signals and the ship's speed data input the pulse signals, the DAU is required. The gyro interface board is optional.

[NOTE]

If the DAU is added, the alert occurs until set the ship's heading angle.



Figure 4-56 Alert: Gyro I/F not set

1. Tap the [Gyro I/F] button on the HOME screen. The GYRO SETUP screen is displayed.

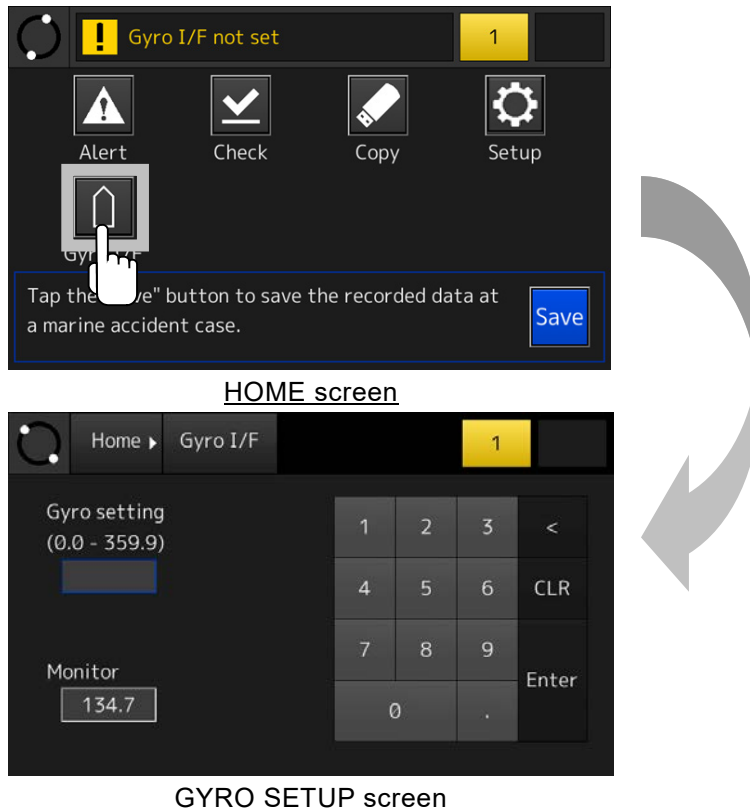

Figure 4-57 GYRO SETUP screen

2. Check the ship's heading angle that the gyro compass displays. Then enter the read value in the [Gyro setting] input box.

[Information]

About how to enter a number, see "4.1.5 Number input".

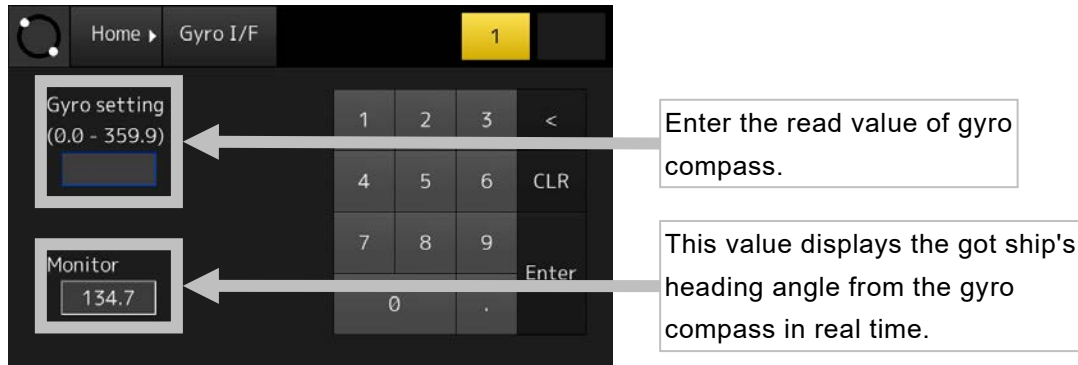

Figure 4-58 Setting the ship's heading angle

3. Make sure that the value of [Monitor] field is the almost same value as the read value of gyro compass. If not, repeat Step 2.

[Information]

The value of [Monitor] field is obtained by converting the got ship's heading angle from the gyro compass by the value of [Gyro setting] field. Therefore, the value of [Monitor] field should be the almost same value as the read value of gyro compass.

4.9 Actions to Take in the Event of an Accident - [Save] Button

If a maritime accident occurred, it is mandatory to preserve the recorded data by the VDR until the time of accident. This section explains guideline for preserving the recorded data.

In the event of an accident, check the situation, and preserve the recorded data immediately. The relevant authorities require that the preserved data be submitted. About the method to transfer the recorded data, contact our head office.

[NOTE]

If the AC input power source is lost, the VDR system shuts down automatically after two hours. If evacuation is necessary, no need to preserve the recorded data. By collecting the fixed protective capsule unit and capsule unit, the relevant authorities can collect the recorded data.

[NOTE]

If the submission of recorded data to the relevant authorities is needed, copy the preserved data to the USB flash drive and submit it.

About how to copy the preserved data, see “4.5 Copying the Recorded Data”

4.9.1 Actions to take at the occurrence of accident

If a maritime accident occurred, tap the [Save] button and display the SAVE screen.

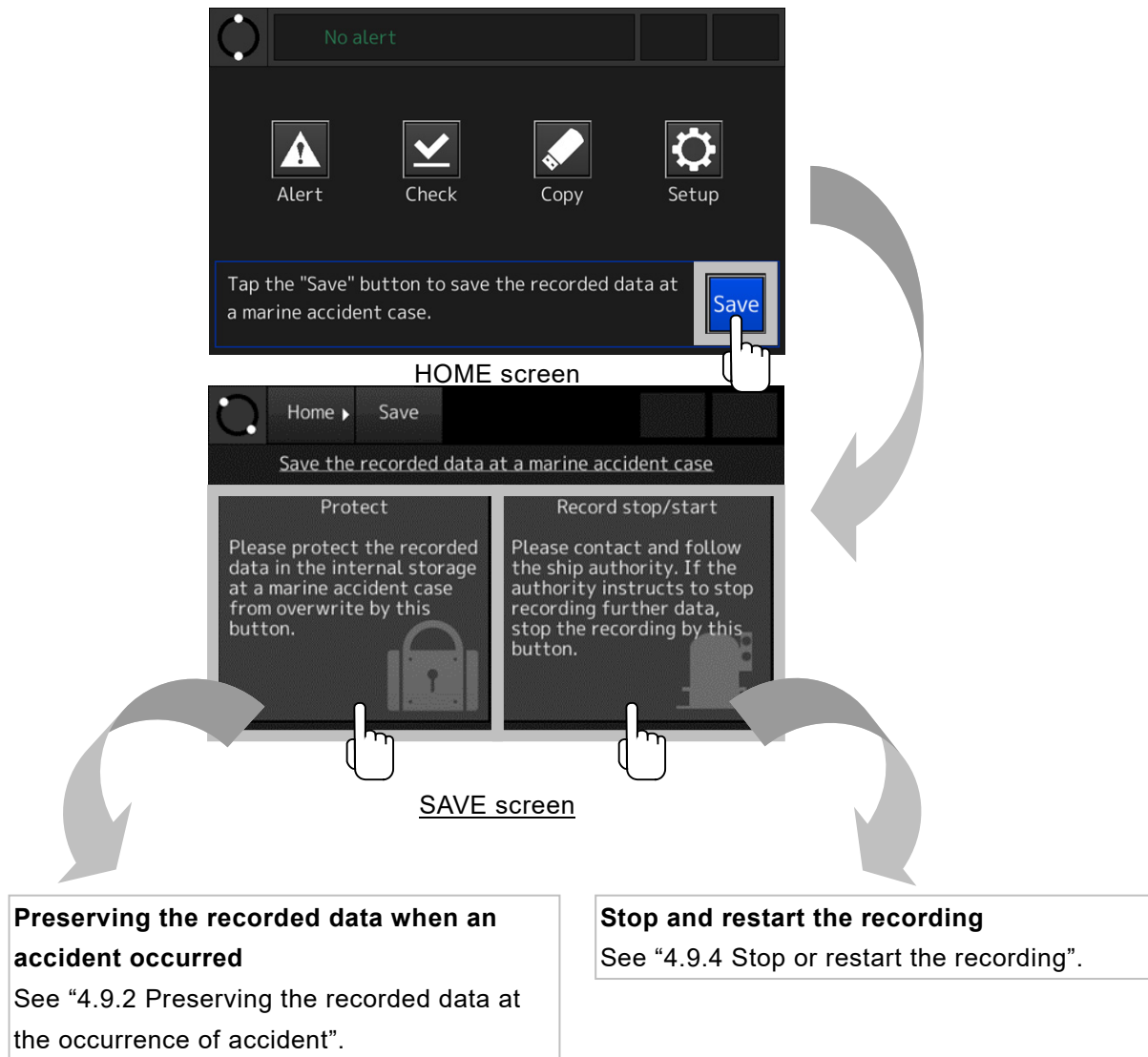

Figure 4-59 SAVE screen

4.9.2 Preserving the recorded data at the occurrence of accident

1. Tap the [Save] button in the HOME screen. The SAVE screen is displayed.

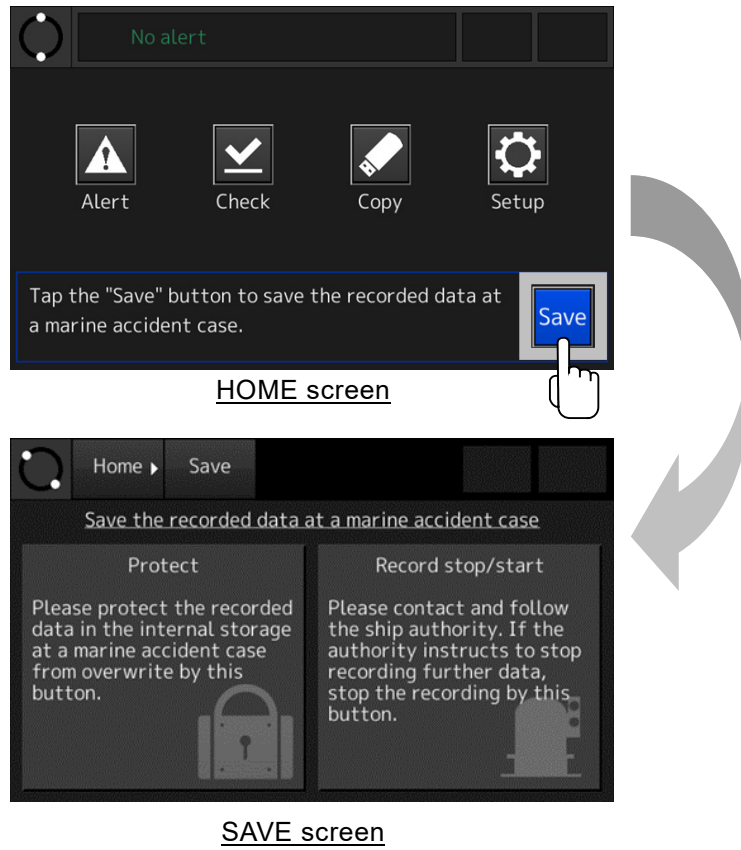

Figure 4-60 SAVE screen

2. Tap the [Protect] button. The DATA PROTECT screen is displayed.



Figure 4-61 DATA PROTECT screen

3. Set the date and time when the accident occurred.

Using four buttons shown in Table 4-26, set the cursor center to the date and time when the accident occurred. As center on the cursor, the recorded data is preserved from three hours before to three hours after. The recorded data is preserved a total of six hours.

[Information]

Even if the recorded data preserved within three hours after the occurrence of the accident, the recorded data is preserved from the occurrence of the accident to three hours later.

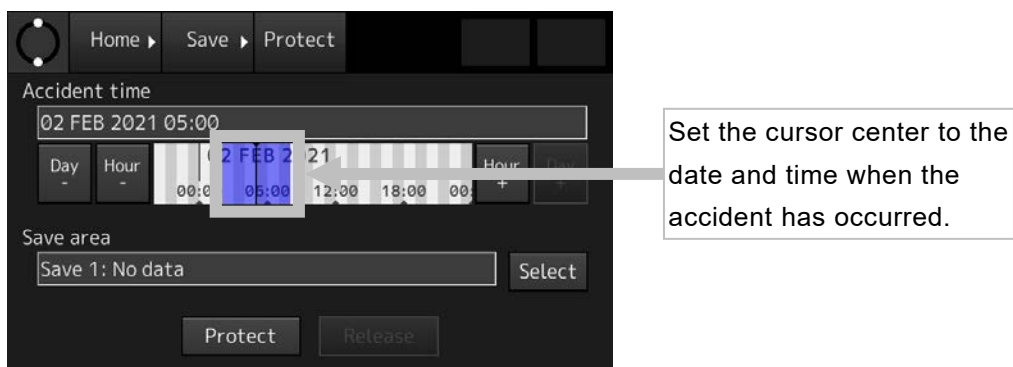

Figure 4-62 Set cursor center to accident time

Table 4-26 The button to set the date and time

Button	Function
Day -	Sets one day before.
Day +	Sets one day after.
Hour -	Sets one hour before.
Hour +	Sets one hour after.

4. Tapping the [Select] button, then the drop-down list is displayed. Select the destination save area to save the preserved data.

[Information]

The number of the save area is up to 3.

If the save area has no space, see “4.9.3 Releasing the preserved data” and release the unnecessary preserved data.

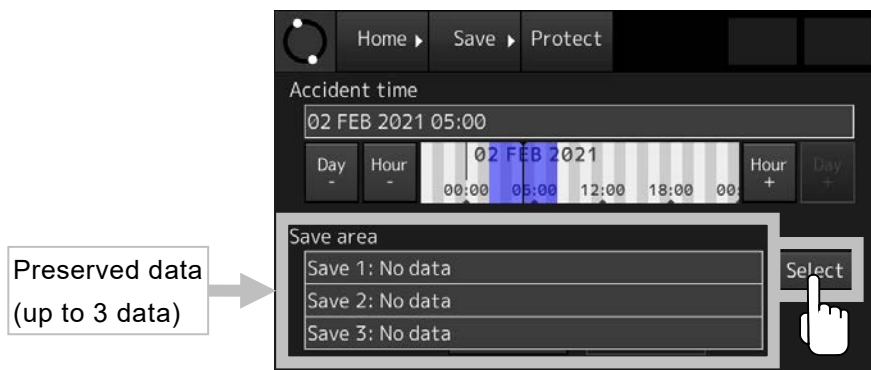

Figure 4-63 Select save area

5. Tapping the [Protect] button, then the chosen recorded data is preserved.

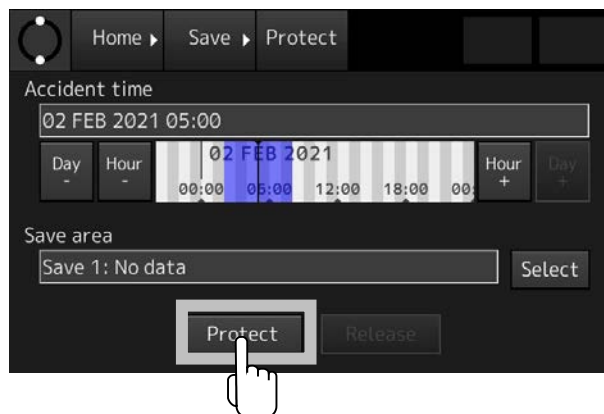

Figure 4-64 [Protect] button

4.9.3 Releasing the preserved data

[NOTE]

It's recommended to leave at least one save area free in order to preserve the recorded data immediately.

1. Tap the [Save] button in the HOME screen. The SAVE screen is displayed.

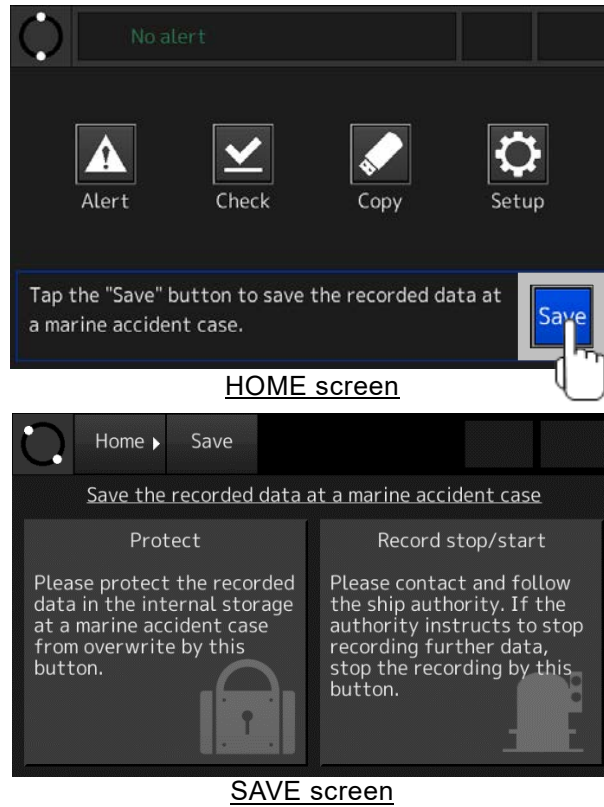

Figure 4-65 SAVE screen

2. Tap the [Protect] button. The DATA PROTECT screen is displayed.

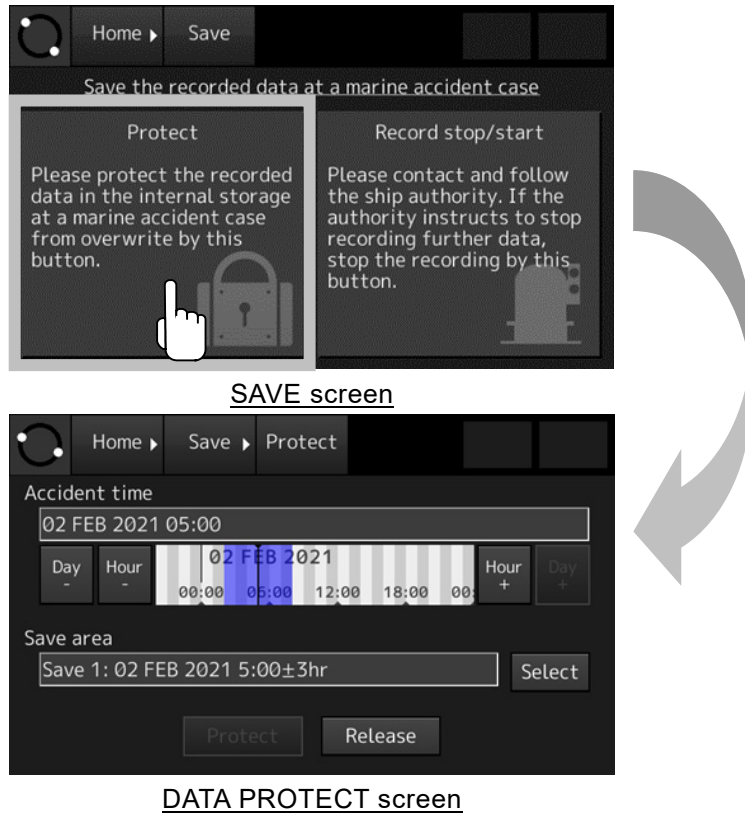

Figure 4-66 DATA PROTECT screen

3. Tapping the [Select] button, then the drop-down list is displayed. Select the preserved data to release from the drop-down list.

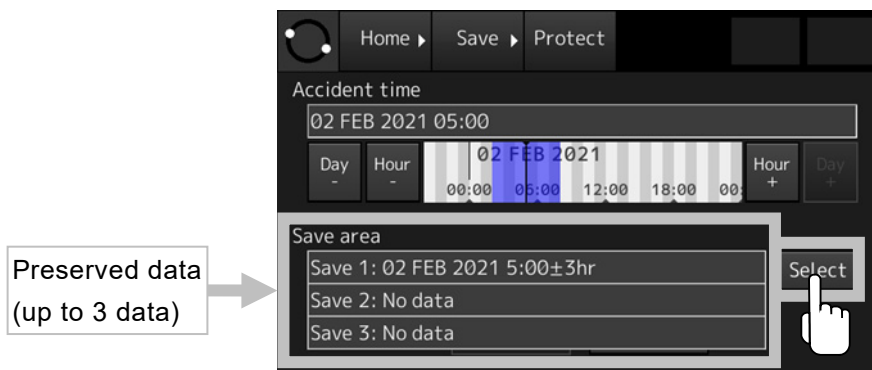
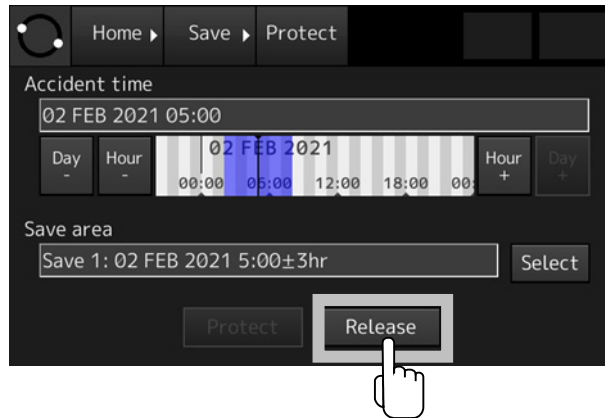
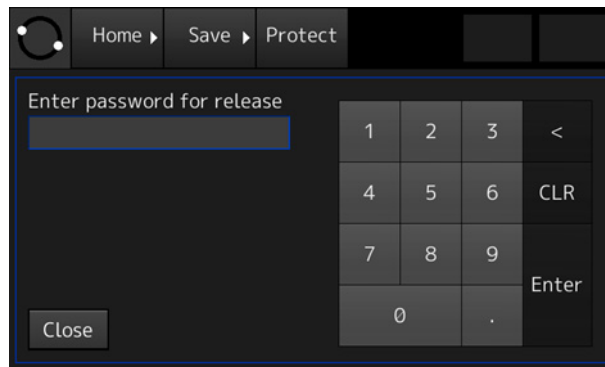

Figure 4-67 Select save area

4. Tapping the [Release] button, then the PASSWORD INPUT screen is displayed.



DATA PROTECT screen



PASSWORD INPUT screen

Figure 4-68 PASSWORD screen

5. Enter the password and tap the [Enter] button. The preserved data is released, and the successful completion message is displayed.

[Information]

The factory default password is "0000". Manage the password by the ship administrator.
About how to enter a number, see "4.1.5 Number input".

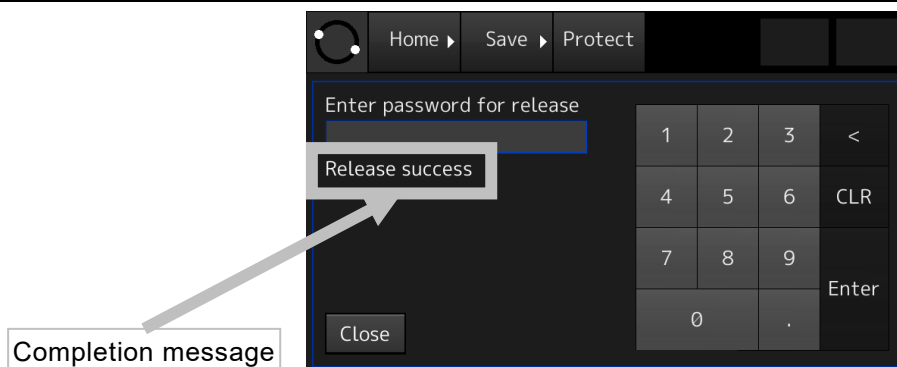

Figure 4-69 Release preserved data

[Information]
 If the password is incorrect, the error message is displayed. Enter the password again.

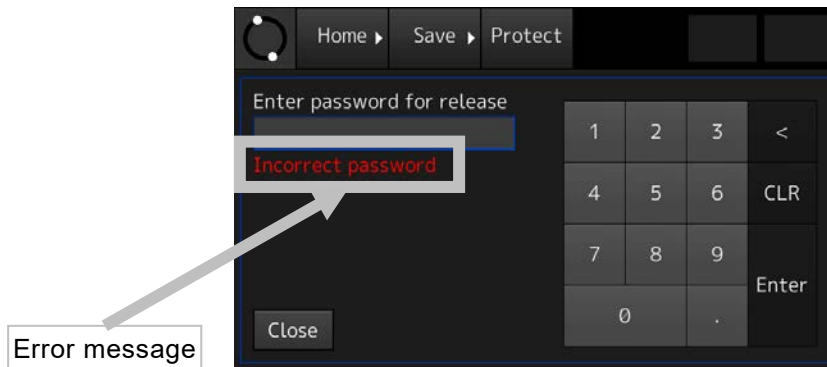

Figure 4-70 Incorrect password error

4.9.4 Stop or restart the recording

Stops or restarts the data recording in the FPC, the FFC and the RCU internal storage.

[NOTE]

- Follow the directions of the relevant authorities as to whether to stop or restart the data recording.
- If the data recording is stopped, the recording to the FPC, the FFC and the internal storage stop. It cannot stop the recording each equipment and each data.

1. Tap the [Save] button in the HOME screen. The SAVE screen is displayed.

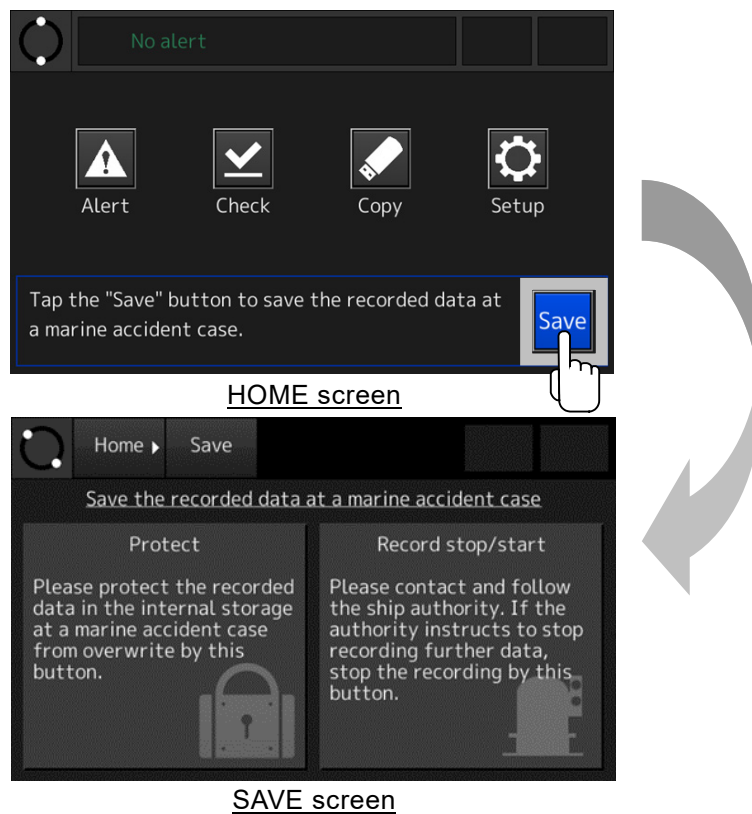

Figure 4-71 SAVE screen

2. Tap the [Record stop/start] button. The RECORD STOP screen is displayed.

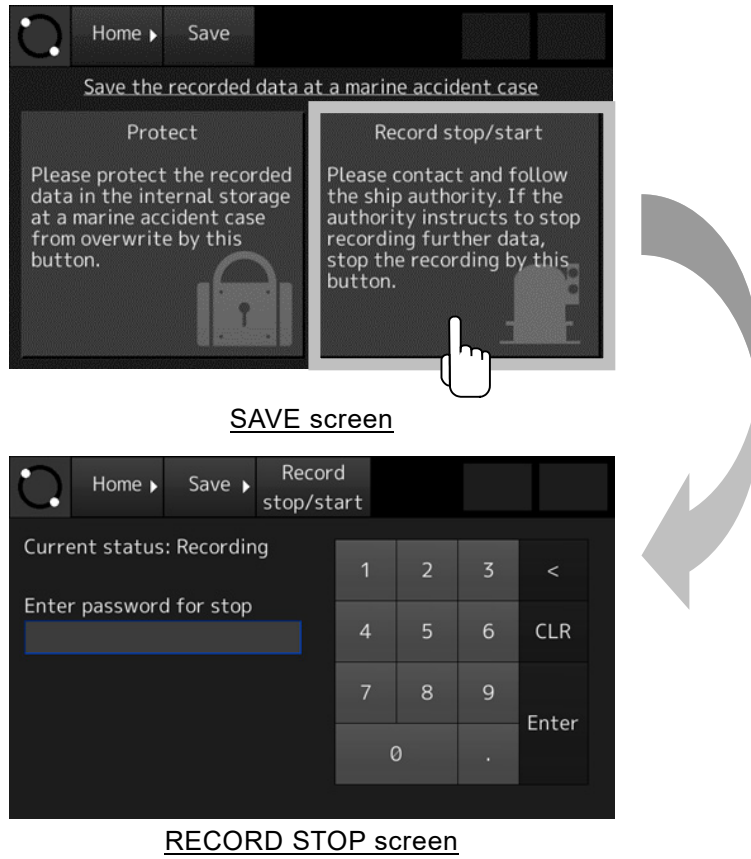

Figure 4-72 RECORD STOP screen

3. Enter the password and tap the [Enter] button. The data recording is stopped, and the successful completion message is displayed.

[Information]

The factory default password is "0000". Manage the password by the ship administrator. About how to enter a number, see "4.1.5 Number input".

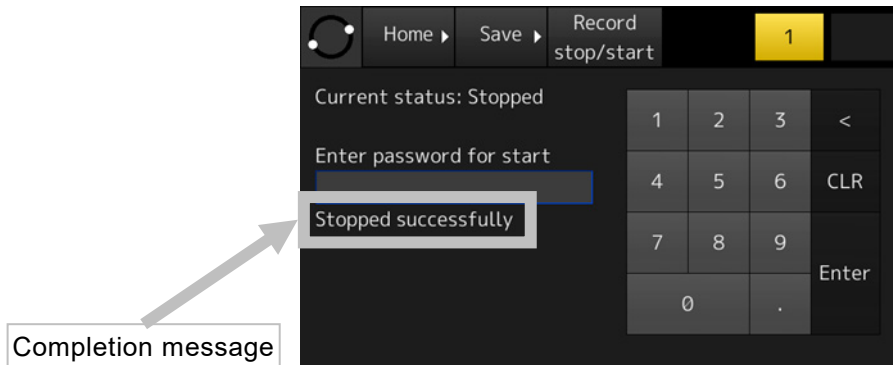

Figure 4-73 Stop data recording

[NOTE]

When the data recording is stopped, the alert occurs.

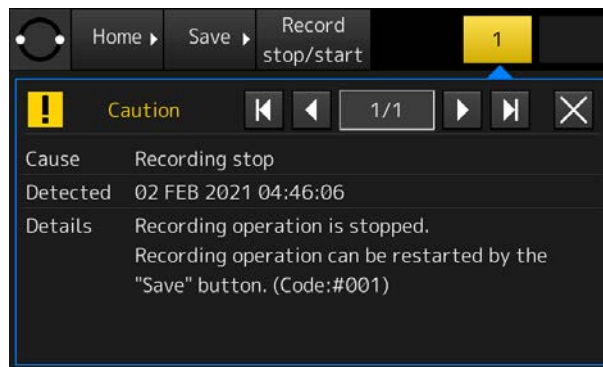

Figure 4-74 Alert: Recording stop

[Information]

If the password is incorrect, the error message is displayed. Enter the password again.

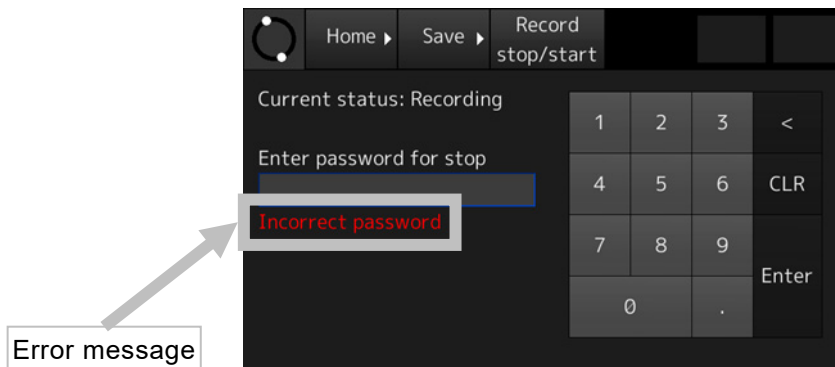

Figure 4-75 Incorrect password error

4. During the recording is stopped, tap the [Record stop/start] button in the SAVE screen. The RECORD START screen is displayed.

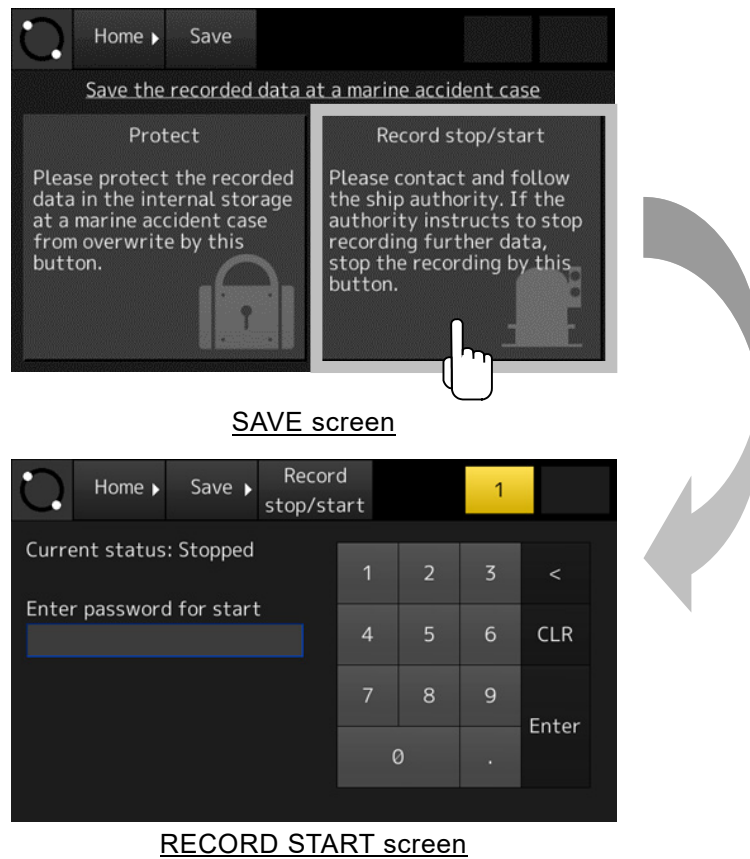

Figure 4-76 RECORD START screen

5. Enter the password and tap the [Enter] button. The data recording is restarted.

[Information]

The factory default password is "0000". Manage the password by the ship administrator. About how to enter a number, see "4.1.5 Number input".

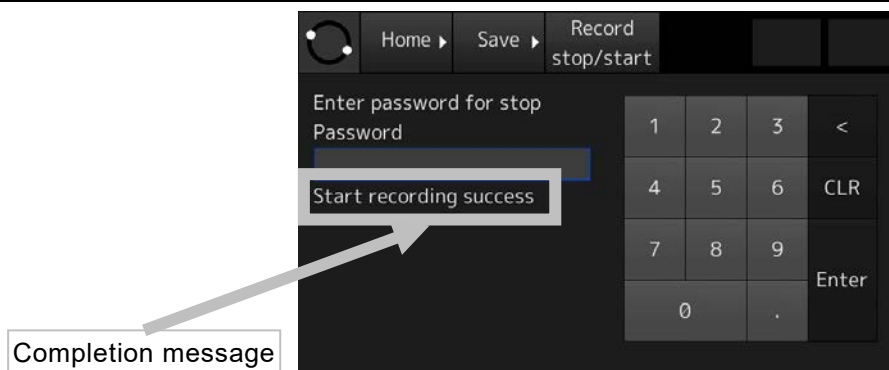

Figure 4-77 Restart data recording

[NOTE]

If the data recording is restarted, the alert disappears.

4.10 Operations Using the Rotary Knob

Explains the on-screen operations by using the rotary knob.

If the touch panel breaks down and cannot be operated, uses the rotary knob.

1. Hold down the rotary knob for 5 seconds.

If the rotary knob is held down for 5 seconds, the function of rotary knob changes from the “Dimmer mode” to the “Operation mode”. In the operation mode, the cursor is displayed on the screen.

[Information]

In the “Operation mode”, the screen brightness cannot adjust by the rotary knob.

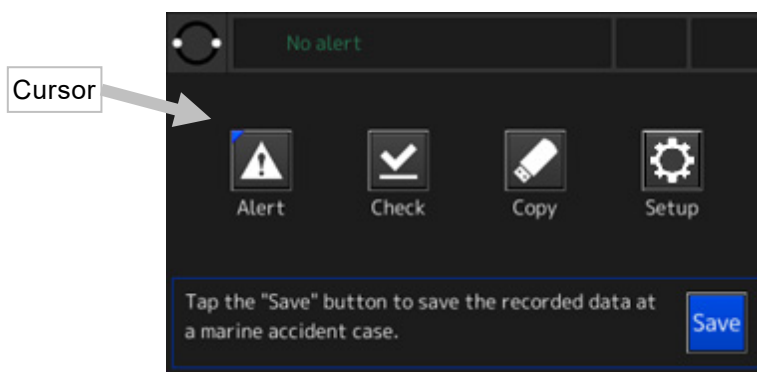

Figure 4-78 Display in the operation mode

2. Move the cursor.

To move the cursor, turning the rotary knob to the left or right.

3. Select the button, then execute.

Move the cursor on the desired button, then press the rotary knob.

4. To return the touch panel operation, push the HOME button.

Chapter 5 About Float-free Capsule



The EPIRB function is built in the Float-free Capsule (FFC). In the EPIRB function, read this section carefully before use.



For more detail, refer to the "USER MANUAL" attached in the Float-free Capsule (FFC).

Attentions before Using







- The EPIRB function of the float-free capsule is a function for searching for the capsule in which the VDR recorded date at the time of an accident and is not an object for lifesaving. JRC cannot accept responsibility for any loss due to incorrect operation, malfunction and other causes except product guarantee condition and liability by law.









Precautions







 DANGER	
	<p>The prohibited matter of a battery and a lithium battery.</p> <ul style="list-style-type: none"> - To short-circuit the + pin and - pin - Using for non-specified applications - Disassembling, modifying, destroying - Throwing into fire, heating - Using expired battery <p>There is a danger that causes leakage of fluid, generation of heat, fire, explosion, destruction, or injury by heat.</p>

 WARNING	
	<p>Do not attempt inspections or repairs on the internal part of the equipment by yourself. Inspections or repairs by anyone other than qualified maintainers may cause a fire or electric shock.</p> <p>Please contact our head office, or a nearby branch or local office to request servicing.</p>
	<p>Do not disassemble or remodel this equipment.</p> <p>Such action may cause a fire, electric shock, or malfunction of the equipment.</p>

WARNING









	<p>If the false distress alert is transmitted, take the following instructions immediately.</p> <p>(1) Stop the transmission immediately.</p> <p>(2) Report the following information to the Maritime Safety Agency.</p> <ul style="list-style-type: none"> (a) Ship's name, type and flag (b) Capsule ID number (15 character UIN) (c) Position and time at the false transmission (d) Cause of the false transmission (e) Type, serial number and delivery date of the capsule <p>In addition, the battery might be exhausted by the transmission of the distress signal. Before the next departure, please contact our head office, or a nearby branch or local office to request the replacement of the battery.</p>
	<p>Do not pull up the capsule from water during distress.</p> <p>If the capsule is taken out from water in distress, it stops sending distress signals.</p>
	<p>The capsule EPIRB function must not be used for other than distress.</p> <p>Otherwise, a large trouble will be given to the search rescue organization.</p>
	<p>Do not set the switch to "ON" except the case of manual activation in distress.</p> <p>Distress signals are transmitted when turning the switch "ON".</p>
	<p>The capsule unit must not be taken out from bracket other than distress.</p> <p>Otherwise, a large trouble will be given to the search rescue organization.</p>
	<p>The selector switch must be set to the "READY" position while voyaging.</p>
	<p>The Hydrostatic Release Unit (HRU) activates the cutter using spring force. Do not disassemble the HRU, nor apply pressure to it. Serious injury could result.</p>

 WARNING	
	Once the Hydrostatic Release Unit (HRU) operates, it cannot be reused. Pay attention for capsule so as not to be stolen or not to be activated by mischief when the ship is in port.
	Confirm that the ship's name and ID correspond to those indicated on the label of the capsule unit. Rescue work will be planned and executed based on the information of ship's name and ID transmitted from the capsule unit. Proper planning of rescue work would not be possible if ship's name and ID are wrong. If the ship's name and ID indicated on the label of the capsule unit is wrong, ask the purchasing dealer, JRC agent or the JRC branches to change it with correct ship's name and ID.
	If right ID cannot be set in the capsule, do not install the capsule. Otherwise, a large trouble will be given to the search rescue organization.
	Do not install the capsule in an extremely vibrating place such as a handrail. The capsule may be damaged due to vibration.
	Do not install the capsule in a strong magnetic field. The capsule may activate by the magnetic force.
	The capsule must be installed apart from the compass and so for the 0.8 meters or more so that the magnetism is not influenced.
	Mount the capsule on the bracket properly. Improper mounting causes the capsule not to be automatically released from the bracket in a sinking.
	The battery and Hydrostatic Release Unit (HRU) which expired effective periods expired must not absolutely be used. If such battery and HRU are used, the distress signal may not be emitted at the distress. Take care that their lives do not expire.

 WARNING	
	<p>Do not install with the capsule battery removed. The distress signal may not be emitted at the distress.</p>
	<p>Do not connect the lanyard to the bracket or ship body. It disturbs at emergency.</p>
	<p>When disposing of the capsule, contact the purchasing dealer, JRC agent or JRC branches to request servicing. If the capsule is transmitted the distress signal by improper disposal, large confusion is caused in search and rescue operations.</p>
	<p>Do not make the used battery to short-circuit, discharging electricity compulsorily or using for other usages. Send used batteries to the purchasing dealer, JRC agent or JRC branches.</p>
	<p>Do not discard used batteries. Send used batteries to the purchasing dealer, JRC agent or JRC branches, to avoid causing environmental problem by throwing them away.</p>
	<p>When sell the ship, contact to the purchasing dealer, JRC agent or JRC branches, and request to register the radio station license and reset up the ship's name and ID. If registration and reset up are not executed, false transmission or wrong ID code signal might be transmitted in distress, and it causes serious confusion for search and rescue operation.</p>



CAUTION

	<p>Open slowly the top cover. If you open faster, the capsule may deviate from bracket and fall down.</p>
	<p>Test the EPIRB function, while anchoring in a port.</p>
	<p>In EPIRB function test, permitted distress signal for the test purpose is transmitted. Do not execute the test repeatedly in a short time.</p>
	<p>Execute the test in 00 to 05 minutes of each o'clock for the reduction of processing capacity in the satellite.</p>
	<p>Do not remove, destroy, or modify warning labels.</p>
	<p>Request purchasing dealer, JRC agent or JRC branches to replace any stained, illegible, or damaged label.</p>
	<p>If the abnormal status is recognized in the capsule. request the service to purchasing dealer, JRC agent or JRC branches,</p>
	<p>If you want to replace or repair the capsule, contact the purchasing dealer, JRC agent or JRC branches.</p>
	<p>Do not use a solvent (paint-thinner, alcohol etc.) or alkaline/neutral detergent to clean up the capsule. It causes crack on the resin if such a detergent is used, and the capsule may not operate properly in the worst case by leaking etc.</p>

5.1 EPIRB Transmission Status

In the Float-free Capsule (FFC), transmission status of the EPIRB function is determined based on the following state.

- Control switch position
- Immersed condition (immersed in water, or not)
- Detachable condition (mounted on the bracket, or released)

Table 5-1 shows the EPIRB transmission status in each case.

[NOTE]

Please transmit at distance of 0.1 m or more from the human body so that the human body is not affected by high frequency during transmission.

Table 5-1 EPIRB transmission status

Control position		FFC condition		FFC mount or release status		Transmission status		Activation type
ON	READY	Wet*	Dry	Release	Mount	ON	OFF	
x		x		x		x		Manual
x		x			x	x		
x			x	x		x		
x			x		x	x		
	x	x		x		x		Automatic
	x	x			x		x	None
	x		x	x			x	
	x		x		x		x	

* Floating or immersed in water.

The new model NDH-339B Float-free Capsule complies with IMO Resolution MSC.494(104) and supports the Return Link System (RLS)^{*1} feature.

The old model NDH-339 doesn't support RLS feature.

Please refer to the "7.13 RLS system" in the User manual issued by Jotron for more details.

*1: The service that can confirm that the distress signal from EPIRB/FFC has arrived at the land station by returning it to EPIRB/FFC via the Galileo satellite.

5.2 Manual Operating and Activation

5.2.1 NDH-339B In case of Float-free capsule complying with MSC.494(104)

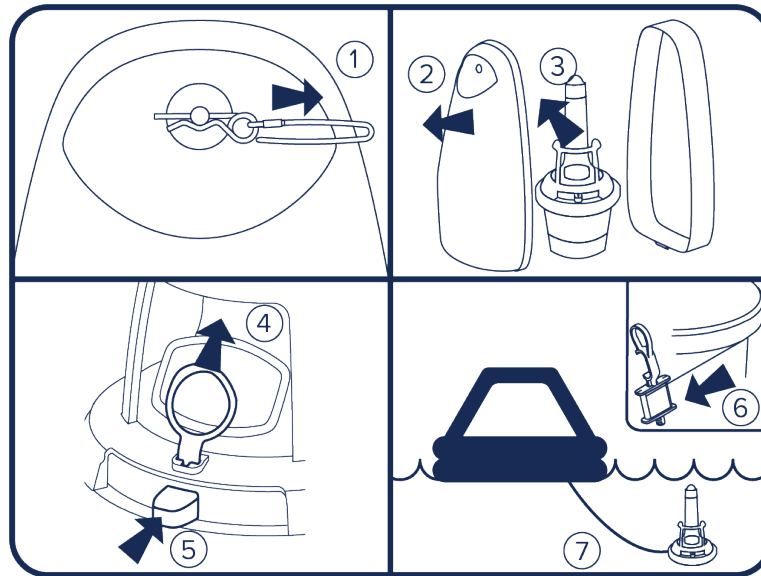

It is recommended to operate the EPIRB inside a life raft, or under a cover or canopy.

Do NOT tie the lanyard to the ship in distress, as this will prevent the unit from functioning if the ship sinks.

1. Remove the locking pin from the front cover.
2. Remove the front cover.
3. Take the EPIRB out of the bracket.
4. Pull the red tab.
5. Push the switch to activate the EPIRB.
6. Unclip and release the lanyard.
7. Tie the lanyard to yourself or to the life raft.

The strobe light will start flashing indicating that the EPIRB is operating.

If possible, keep the EPIRB in an open area, away from any metal objects (ship construction etc.) that may limit the satellite coverage.

Transmissions can be stopped by taking the EPIRB out of water and turning the switch to middle position.

5.2.2 NDH-339 In case of Float-free capsule before complying with MSC.494(104)

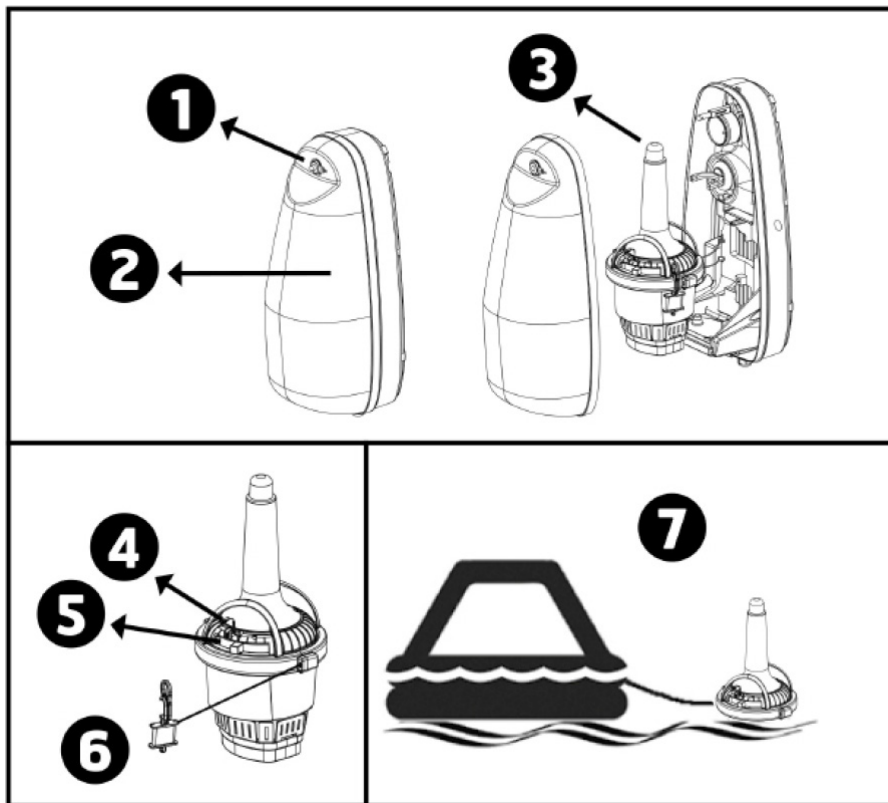

It is not recommended to operate the EPIRB function inside a life raft or under a cover or canopy. Do not tie the lanyard (mooring rope) to the ship in distress, as this will prevent the unit to functioning if the ship sinks.

1. Remove the locking pin from bracket.
2. Remove the front cover.
3. Take out the capsule from the bracket.
4. Break the seal and pull the locking pin holding the switch.
5. Push and move switch to the left, to "ON" position. The LED indicator, located at the top of the capsule, will start to flash, indicating that the EPIRB function is operating.
6. Tie the capsule lanyard to oneself or to the survival craft.
7. If possible, keep the capsule in an open area, away from any metal objects (ship construction etc.) that may limit the satellite coverage. This is especially important for the capsule, since it needs good reception to obtain a GPS position.

[NOTE]

To stop transmission, take the capsule out of the water and move the switch to "READY" position.

Wrist Strap (If provided)

In a distress situation, the float-free capsule can be carried by using the provided wrist strap, where it is necessary to have both arms free, e.g. when climbing a ladder.

How to use

1. Pull the black wrist strap of the pocket.

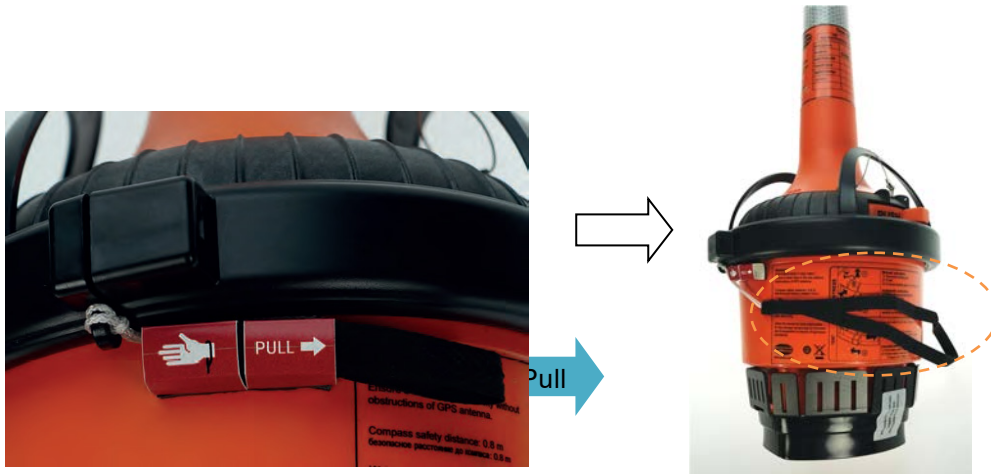

State when the wrist strap is pulled out

2. Put your arm through the loop of the wrist strap and carry the float-free capsule.



[NOTE]

It is impossible to return the wrist strap into the pocket after usage.

If mistake to pull the wrist strap, please contact our head office, or a nearby branch or local office to request servicing.

5.3 EPIRB Function Testing -NDH-339B In case of complying with MSC.494(104)-

As a periodical inspection, please perform every month. There are two different kinds of tests:

1. NORMAL SELF-TEST
2. EXTENDED SELF-TEST including the GNSS-test

[NOTE]

- Perform the periodic inspection, while anchoring in a port.
- What the NORMAL SELF-TEST and the EXTENDED SELF-TEST actually does is to send out a short test signal on 121.5MHz, 406.031MHz and AIS, testing the output of the transmitter. While transmitting the test signal, the battery voltage, output power and phase lock is tested.
- During the test of the 406MHz transmitter a test message is transmitted, this test message is coded with a special synchronization code and will not be recognized as real alert by the Cospas-Sarsat satellites.
- The EXTENDED SELF-TEST include the self-test ("5.3.1 NORMAL SELF-TEST") and therefore only one of them are necessary.
- Limit this test to max. once/month as this test will reduce lifetime of EPIRB battery. Number of the EXTENDED SELF-TEST is limited to 60 for a period of 5 years.

5.3.1 NORMAL SELF-TEST



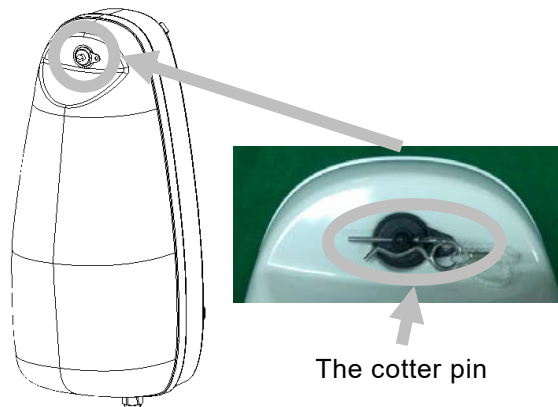



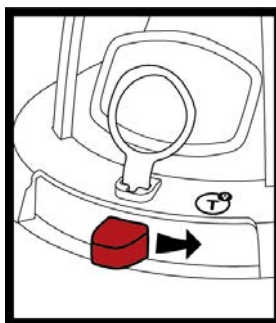



1. Release front cover by removing the cotter pin.



2. Move the switch to Test position and hold until the test indicator light is on.



3. During the normal self-test, the test indicator will blink.
4. If the self-test is successful, the Strobe light will flash once.
5. If the self-test detects a fault in the EPIRB module, the test indicator LED will start flashing at the end of the test.

 Test sequence	 Position indicator	 RLS indicator	 Test indicator	 Strobe light
NORMAL SELF-TEST Started	—	—	 On	—
Signals Transmitted	—	—	 Multiple short Off periods	—
RLS enabled*1	—	 One for 1 second	—	—
Extended self-test successful	—	—	—	 One flash
If one of the above tests are unsuccessful, the remaining test sequences will not be performed, and the test indicator will indicate self-test failure.				
Self-test failure	—	—	 Multiple flashes*2	—

*1 : For EPIRBs with RLS (Return Link System) disabled the RLS indicator will remain off.

*2 : See the Table 5-2 for on failure indications.

5.3.2 EXTENDED SELF-TEST

The test which is included GNSS test in the NORMAL SELF-TEST

1. Release front cover by removing the cotter pin.

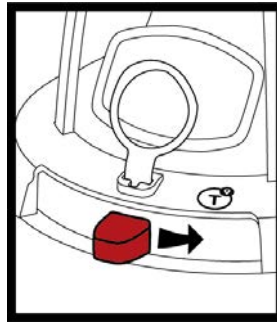
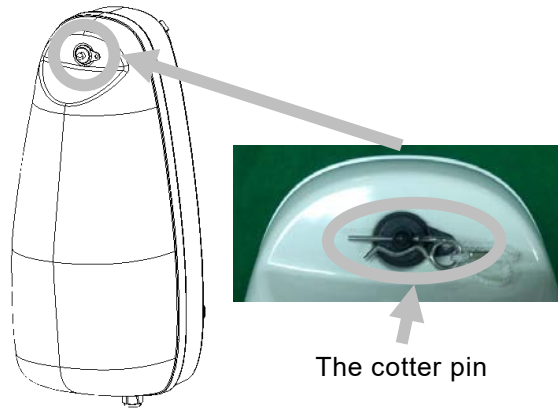

2. To perform the EXTENDED SELF-TEST, do the following steps within a period of 3 seconds.

- 1) Move the switch to Test position.
- 2) Release middle position.
- 3) Move the switch to test position and release when the white test indicator lights up.













The white test indicator LED will light up and the green GNSS indicator LED will start flashing in sequences of 3 fast flashes. This indicates that the EPIRB is searching for a validated position.

When a valid position is found the green GNSS indicator LED will remain lit for approximately 1 second and a NORMAL SELF-TEST will continue.

The Strobe light will flash once at the end of the test if the EXTENDED SELF-TEST is successful.

If the self-test detects a fault in the EPIRB module, the test indicator LED will start flashing at the end of the test. For fault codes see the table in the Table 5-2.

Note that the extended self-test can only be performed 60 times. After that the self-test will indicate “maximum number of extended self-tests exceeded”.

 Test sequence	 Position indicator	 RLS indicator	 Test indicator	 Strobe light
EXTENDED SELF-TEST started	—	—	 On	—
Waiting for position	 Triple flashes	—	—	—
Position achieved	 On for 1 second	—	—	—
Self-test started	—	—	 On	—
Signals Transmitted	—	—	 Multiple short Off periods	—
RLS enabled*1	—	 On for 1 second	—	—
EXTENDED SELF-TEST successful	—	—	—	 One flash
If one of the above tests are unsuccessful, the remaining test sequences will not be performed, and the test indicator will indicate self-test failure.				
Self-test failure			 Multiple flashes*2	

*1 : For EPIRBs with RLS (Return Link System) disabled the RLS indicator will remain off.

*2 : See the Table 5-2 for on failure indications.

Table 5-2 Error message by LED flashing

 Number of flashes	Failure indication
2	Battery failure
3	Transmitter failure
4	—
5	No position
6	—
7	Maximum number of EXTENDED SELF-TESTs exceeded
8	—
9	—
10	Other faults

5.4 EPIRB Function Testing -NDH-339 In case of before complying with MSC.494(104)-

As a periodical inspection, please perform every month. There are two different kinds of tests:

1. NORMAL SELF-TEST
2. EXTENDED SELF-TEST including the GPS-test

[NOTE]

- Perform the periodic inspection, while anchoring in a port.
- What the NORMAL SELF-TEST and the EXTENDED SELF-TEST actually does is to send out a short test signal on 121.5 and 406.037MHz, testing the output of the transmitter. While transmitting the test signal, the battery voltage, output power and phase lock is tested.
- During the test of the 406MHz transmitter a test message is transmitted, this test message is coded with a special synchronization code and will not be recognized as real alert by the Cospas-Sarsat satellites.
- The EXTENDED SELF-TEST include the self-test ("5.3.1 NORMAL SELF-TEST") and therefore only one of them are necessary.
- The GPS-test might take up to 2 minutes to be successful. Limit this test to max. once/month as this test will reduce lifetime of EPIRB battery. Number of the EXTENDED SELF-TEST is limited to 60 for a period of 5 years.

5.4.1 NORMAL SELF-TEST

1. Release front cover by removing the cotter pin.

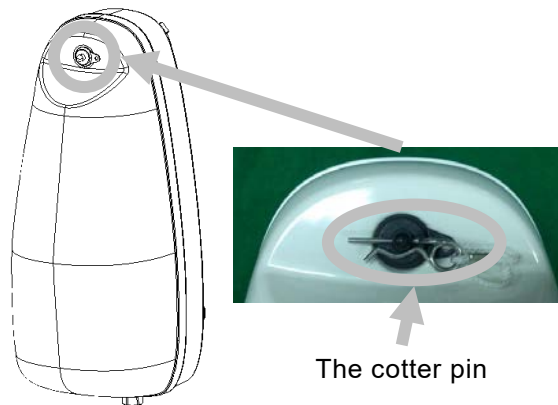

2. Push and hold switch in "TEST" position for 15 seconds.

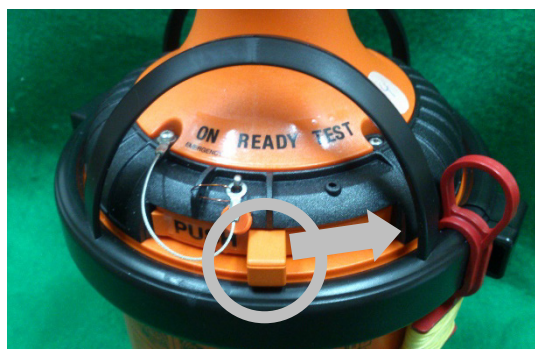

3. The test results judge by the LED that is the top of storage module. If the LED flashes only once, the test is pass.



Table 5-3 Error message by LED flashing

Number of flashing	Fault indication
1	None
2	Low power on 406MHz transmitter
3	Low battery voltage
4	Low power on 121.5MHz transmitter
5	PLL on 406MHz transmitter out of lock
6	PLL on 121.5MHz transmitter out of lock
7	EPIRB module not programmed or programming not complete

4. If the test is pass, release the switch and fit the front cover.

5.4.2 EXTENDED SELF-TEST including GPS-test

1. Release front cover by removing the cotter pin.

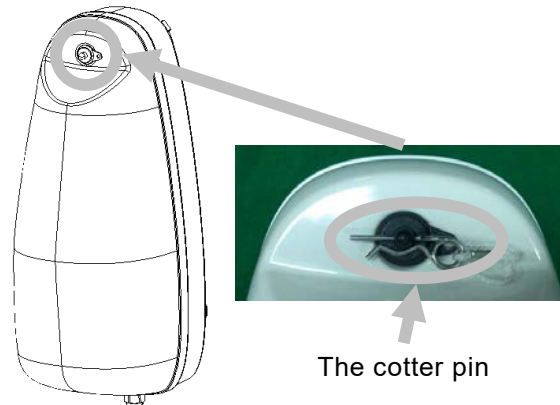

2. Move switch to “TEST” position twice within 3 seconds and release back to “READY” position.



3. A short beep sounds, and the test starts. During the test, until the capsule acquires the GPS position, a short beep sounds every three seconds.
4. It's possible to determine the test results by the number of beeps. If the GPS has been acquired successfully, a beep sounds consecutively twice.

Table 5-4 Error message by beep

Number of beeps	Fault indication
2	None
5	Did not acquire the GPS position
10	Number of GPS-test exceeds limit (> 60)

5. The NORMAL SELF-TEST is performed after successful GPS-test and position transmitted on 406.037MHz. The GPS position may also be received on the EPIRB tester for verification.
-

5.5 Attention point at mounting the capsule

When remove the capsule in order to perform NORMAL SELF-TEST, EXTENDED SELF-TEST including GNSS (or GPS) test for periodic maintenance or due to occurring communication error, return the capsule into the bracket after wiping the silicone grease and applying a thin layer of the attached silicone grease.

If the silicone grease is not applied, please note that it may cause a communication error.



Applying of silicone grease

When return the capsule into the bracket, confirm that capsule is mounted without no gap between the capsule and the following 2 places (Hunger part and Docking module part).

If there is gap, please re-mount the capsule so that there is no gap.

If there is gap, please note that it may cause a communication error.

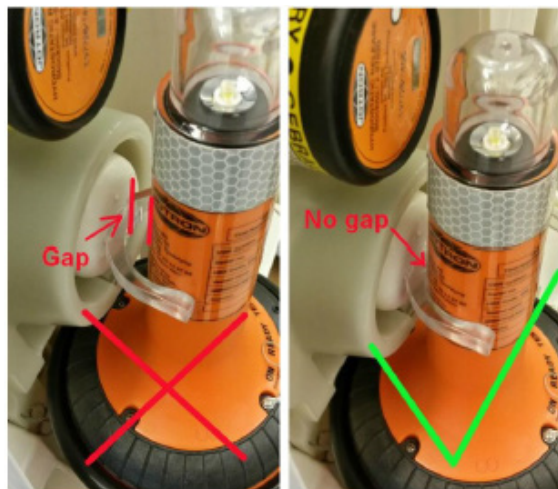

NG

OK

Hunger part



NG

OK

Docking Module part

5.5.1 Visual inspection

As the visual inspection, please check the followings:

1. When the capsule release away, checks that there is no obstacle in the circumference of the bracket.
2. Check for defects on the capsule and the bracket.
3. Make sure that the capsule and bracket are not painted or otherwise covered with chemicals, oil, etc.
4. The lanyard should be firmly attached to the capsule. The lanyard should not be tied to the vessel.

5.5.2 Check the expire date

Please check the following. If the expire date is approaching, please contact our head office, or a nearby branch or local office to request servicing.

1. SBM

Part of year and month of SBM deadline is cut.

2. Hydrostatic Release Unit (HRU)

Check is attached on year and month of the expire date.

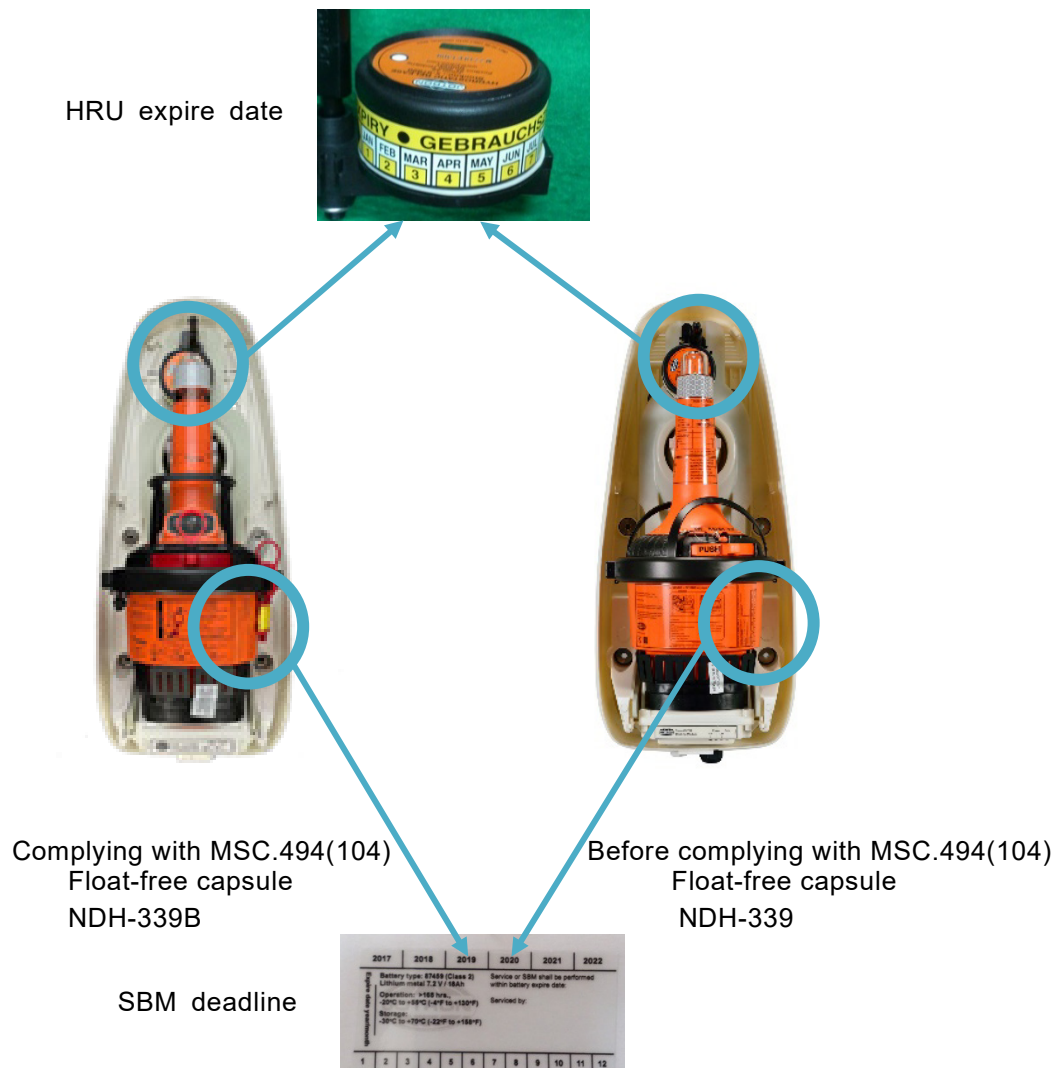

(Blank page)

Chapter 6 Maintenance and Inspection

WARNING



Do not attempt inspections or repairs on the internal part of the equipment by yourself. Inspections or repairs by anyone other than qualified maintainers may cause a fire or electric shock.

Please contact our head office, or a nearby branch or local office to request servicing.

CAUTION



Do not use any organic solvents such as thinner or benzine to clean the surface. Otherwise, the surface coating may be damaged.

Be sure to remove dirt and dust from the surface and wipe it using a clean dry cloth.

6.1 Daily Maintenance

The life of this equipment depends greatly on the quality of maintenance. To keep this equipment in the best operating condition, perform equipment inspections regularly. By the inspection, problems can be identified before they develop into major malfunctions.

6.1.1 Cleaning

CAUTION



If the equipment is splashed with freshwater or seawater, wipe it immediately. Otherwise, it may cause a failure or operational malfunctions.

To remove stains from the equipment, gently wipe it using a soft cloth dampened with neutral detergent.

6.1.2 Checking the expiration date of battery

Check the expiration date of the RCU built-in battery, the underwater acoustic beacon of the fixed protective capsule unit and the float-free capsule unit built-in battery. If the expiration date is approaching, please contact our head office, or a nearby branch or local office to request servicing.

6.1.3 The list of the replacement parts

No.	Component Name	Code	Replacement period
1	Replacement parts kit for the RCU	7ZZNA4134	---
2	Battery for the RCU	CBN80	4 and a half years after manufacturing
3	Cooling fan for the RCU	7BFNA4002	4 and a half years after installing
4	Beacon for the FPC	7ZZNA4138	3 years after manufacturing
5	Memoryless capsule for the FFC	CGK339/ CGK339B*	At SBM 5 years after installing, 4 years depending on flag state
6	HRU for the FFC	7ZZNA4150	2 years after installing
7	OPU	NCG1900	Operating time: 50,000 hours
8	Cooling fan for the FGU	7BFNA4001	4 and a half years after installing

*The CGK339B is replacement unit complying with MSC.494(104).

The CGK339B will be shipped as soon as CGK339 is out of stock.

6.1.4 Changing the vessel specific information and the connected device

When changing the vessel specific information (e.g. ship name) and the connected device, change the settings of the VDR system is required. Please contact our head office, or a nearby branch or local office to request servicing.

6.2 Periodic Inspection

It's recommended to check this equipment interior, power cable connection and connection to the other equipment. The periodic inspection is a charge.

Annual maintenance is requested by Ship Class. Please contact our head office, or a nearby branch or local office to request servicing.

6.3 Troubleshooting

If the VDR malfunctions, troubleshoot it according to the following list. Read the cause and take the actions recommended on the list.

If the malfunction persists or there is a problem not listed below, contact your sales representative, our sales department, nearest branch office or sales office.

6.3.1 In case of trouble

Trouble symptom	Cause	Actions to take
The MCB's LED (SYS. or REC.) does not turn on.	The RCU's POWER switch does not turn on.	Turn on the RCU's POWER switch.
	The AC-line fuse is blowing out.	After the power supply to the RCU is stopped, check the PSU's AC-line fuse. If the AC-line fuse is blowing out, replace with the spare fuse.
	The power supply is not supplied from the switchboard.	Check the switchboard.
	The PSU is breaking down.	Contact your sales representative, our sales department, nearest branch office or sales office.
The OPU's screen is not displayed.	The OPU's screen brightness is becoming low.	Adjust the screen brightness by the rotary knob.
	The life of OPU's LCD is approaching.	Check the OPU's operating time. See "4.7.4 Checking the replacement parts". If the OPU's operating time is over 50,000 hours, it is necessary to replace the OPU. Contact your sales representative, our sales department, nearest branch office or sales office.
	The power supply is not supplied to the OPU.	1) Check the LAN cable 2) Reboot the RCU.
The OPU cannot operate.	The function of rotary knob is becoming the operation mode.	Push the HOME button in the OPU.
	The rotary knob is breaking out.	It is necessary to replace the OPU. Contact your sales representative, our sales department, nearest branch office or sales office.

Trouble symptom	Cause	Actions to take
The LCD screen became dark.	The OPU's screen brightness is becoming low.	Adjust the screen brightness by the rotary knob.
	The life of OPU's LCD is approaching.	Check the OPU's operating time. See "4.7.4 Checking the replacement parts". If the OPU's operating time is over 50,000 hours, it is necessary to replace the OPU. Contact your sales representative, our sales department, nearest branch office or sales office.
Recording data cannot be copied to USB flash drive.	Cannot find USB flash drive.	Remove the USB flash drive and reboot the RCU and check the recording data can be copied normally. If there is still a problem, please contact our head office, or a nearby branch or local office to request servicing.

6.3.2 List of alerts

Code	Title	Description	Actions to take
000	RCU fail	OPU cannot communicate with RCU. Reboot VDR.	1) Check the cable. 2) Reboot the RCU.
001	Recording stop	Recording operation is stopped.	When the data recording stopped to prevent overwriting data, this message is displayed. Follow the directions of the relevant authorities as to whether to restart the data recording. About restarting the data recording, see "4.9.4 Stop or restart the recording".
002	Power fail	Power is not supplied. Check switchboard.	1) Check the switchboard. 2) Check the POWER switch. Turn on the POWER switch. 3) Check the AC line fuse in the RCU. If the AC line fuse blown, replace the fuse.

Code	Title	Description	Actions to take
003	Low battery	Cannot operate during blackout.	Check the RCU's built-in battery. Turn on the POWER switch and charge the battery.
004 005	Fan* fail *: 1, 2	Fan* doesn't work. Need replacing. *: 1, 2	It is necessary to replace the fan. Please contact our head office, or a nearby branch or local office to request servicing.
009	Battery fail	Cannot operate during blackout.	It is necessary to replace the battery. Please contact our head office, or a nearby branch or local office to request servicing.
031	Lost time source	VDR time synchronization doesn't work.	Check the GPS. If the GPS is working normally, please contact our head office, or a nearby branch or local office to request servicing.
041 042	OPU* fail *: 1, 2	OPU* doesn't work. Reboot VDR. *: 1, 2	1) Check the cable. 2) Reboot the RCU.
101	FPC short period	Recording period is shorter than 48 hours.	The image size may be too large temporarily by radar echo. Check the gain of the radar and watch the state for a few days.
103	FPC record fail	Unable to record. Check unit and cable.	1) Check the cable. 2) Reboot the RCU.
104	FFC short period	Recording period is shorter than 48 hours.	The image size may be too large temporarily by radar echo. Check the gain of the radar and watch the state for a few days.
106	FFC record fail	Unable to record. Check unit and cable.	1) Check the cable. 2) Reboot the RCU.
107	SSD short period	Recording period is shorter than 720 hours.	The image size may be too large temporarily by radar echo. Check the gain of the radar and watch the state for a few weeks.
110 111	SSD* record fail *:1, 2	Unable to record. Reboot VDR.	Reboot the RCU and check it works normally. If there is still a problem, please contact our head office, or a nearby branch or local office to request servicing.

Code	Title	Description	Actions to take
201 to 212	Lost MIC CH* *: 1 to 12	Failed to self-test. Check and try re-test.	1) Check the wiring between the RCU and the microphone. 2) In environment without a loud noise, retry the self-diagnosis test. See "4.6.4 Checking the audio data"
224	ARB fail	Unable to record audio.	Reboot the RCU and check it works normally. If there is still a problem, please contact our head office, or a nearby branch or local office to request servicing.
301 to 324	Lost serial CH* *:1 to 24	Unable to record. Check sensor and cable.	1) Check the cable. 2) Check the equipment that is displayed.
350 to 373	Lost LAN No* *:1 to 24	Unable to record. Check sensor and cable.	1) Check the cable. 2) Check the equipment that is displayed.
390 to 399	Lost DAU1 CH* *:1 to 10	Unable to record. Check sensor and cable.	1) Check the wiring between the RCU and the DAU. 2) Check the wiring between the DAU and the sensor. 3) Check the equipment that is displayed.
400	Lost DAU1 DAU	Unable to record. Check sensor and cable.	1) Check the wiring between the RCU and the DAU. 2) Check the DAU.
401	Lost DAU1 analog	Unable to record. Check sensor and cable.	1) Check the wiring between the RCU and the DAU. 2) Check the DAU.
402	Lost DAU1 gyro	Unable to record. Check sensor and cable.	1) Check the wiring between the RCU and the DAU. 2) Check the DAU.
403 to 412	Lost DAU2 CH* *:1 to 10	Unable to record. Check sensor and cable.	1) Check the wiring between the RCU and the DAU. 2) Check the wiring between the DAU and the sensor. 3) Check the equipment that is displayed.
413	Lost DAU2 DAU	Unable to record. Check sensor and cable.	1) Check the wiring between the RCU and the DAU. 2) Check the DAU.

Code	Title	Description	Actions to take
414	Lost DAU2 analog	Unable to record. Check sensor and cable.	1) Check the wiring between the RCU and the DAU. 2) Check the DAU.
415	Lost DAU2 gyro	Unable to record. Check sensor and cable.	1) Check the wiring between the RCU and the DAU. 2) Check the DAU.
416 to 425	Lost DAU3 CH* *:1 to 10	Unable to record. Check sensor and cable.	1) Check the wiring between the RCU and the DAU. 2) Check the wiring between the DAU and the sensor. 3) Check the equipment that is displayed.
426	Lost DAU3 DAU	Unable to record. Check sensor and cable.	1) Check the wiring between the RCU and the DAU. 2) Check the DAU.
427	Lost DAU3 analog	Unable to record. Check sensor and cable.	1) Check the wiring between the RCU and the DAU. 2) Check the DAU.
428	Lost DAU3 gyro	Unable to record. Check sensor and cable.	1) Check the wiring between the RCU and the DAU. 2) Check the DAU.
429 to 438	Lost DAU4 CH* *:1 to 10	Unable to record. Check sensor and cable.	1) Check the wiring between the RCU and the DAU. 2) Check the wiring between the DAU and the sensor. 3) Check the equipment that is displayed.
439	Lost DAU4 DAU	Unable to record. Check sensor and cable.	1) Check the wiring between the RCU and the DAU. 2) Check the DAU.
440	Lost DAU4 analog	Unable to record. Check sensor and cable.	1) Check the wiring between the RCU and the DAU. 2) Check the DAU.
441	Lost DAU4 gyro	Unable to record. Check sensor and cable.	1) Check the wiring between the RCU and the DAU. 2) Check the DAU.
442	Serial port fail	Unable to record sensor via serial.	Reboot the RCU and check it works normally. If there is still a problem, please contact our head office, or a nearby branch or local office to request servicing.

Code	Title	Description	Actions to take
443	Sensor LAN fail	Unable to record sensor via LAN.	Reboot the RCU and check it works normally. If there is still a problem, please contact our head office, or a nearby branch or local office to request servicing.
461	Gyro I/F not set	Heading is incorrect. Set initial value.	Set the initial heading angle.
501	Lost S-BAND	Unable to record. Check S-BAND and cable.	1) Check the cable. 2) Check the S-band radar.
502	Lost X-BAND	Unable to record. Check X-BAND and cable.	1) Check the cable. 2) Check the X-band radar.
503	Lost ECDIS	Unable to record. Check ECDIS and cable.	1) Check the cable. 2) Check the ECDIS.
504	Image LAN fail	Unable to record image via LAN.	Reboot the RCU and check it works normally. If there is still a problem, please contact our head office, or a nearby branch or local office to request servicing.
557 to 559	FGU* fan fail *: 1 to 3	FGU* fan doesn't work. Need replacing. *: 1 to 3	It is necessary to replace the fan. Please contact our head office, or a nearby branch or local office to request servicing.
569 to 571	FGU* fail *: 1 to 3	Unable to record image via FGU. Check unit.	1) Check the LAN cable. 2) Reboot the FGU. 3) Reboot the RCU.
992	Main LAN Stop	Main LAN is stopped due to high traffic.	Please contact our head office, or a nearby branch or local office to request servicing.
993	Sub LAN Stop	Sub LAN is stopped due to high traffic.	Please contact our head office, or a nearby branch or local office to request servicing.
994	Ex1 LAN Stop	Ex1 LAN is stopped due to high traffic.	Please contact our head office, or a nearby branch or local office to request servicing.
995	Ex2 LAN Stop	Ex2 LAN is stopped due to high traffic.	Please contact our head office, or a nearby branch or local office to request servicing.

[NOTE]

According to the definition in IEC62923, all alerts of this equipment are assigned to priority "Caution" and category "B". When new alert occurs, according to the definition of caution alert, that alert is displayed automatically on the OPU but no audible signal occurs.

6.3.3 List of information

Code	Title	Description	Actions to take
059	Battery life	Expiration date is close. Need replacing.	It is necessary to replace the underwater acoustic beacon. Please contact our head office, or a nearby branch or local office to request servicing.
060	FPC beacon life	Expiration date is close. Need replacing.	It is necessary to replace the underwater acoustic beacon. Please contact our head office, or a nearby branch or local office to request servicing.
061	FFC SBM deadline	SBM deadline is close. Need replacing.	It is necessary to replace the battery. Please contact our head office, or a nearby branch or local office to request servicing.
062	RCU fan life	Expiration date is close. Need replacing.	It is necessary to replace the fan. Please contact our head office, or a nearby branch or local office to request servicing.
063 to 065	FGU* fan life *: 1 to 3	Expiration date is close. Need replacing.	It is necessary to replace the fan. Please contact our head office, or a nearby branch or local office to request servicing.
066	FFC HRU life	Expiration date is close. Need replacing.	It is necessary to replace the hydrostatic release unit. Please contact our head office, or a nearby branch or local office to request servicing.
108 109	SSD* access fail *: 1, 2	Unable to access. VDR capacity is reduced.	Reboot the RCU and check it works normally. If there is still a problem, please contact our head office, or a nearby branch or local office to request servicing.
513 to 520	Lost image No* *: 1 to 6	Unable to record. Check unit and cable.	1) Check the cable. 2) Check the display equipment.
991	RMS connection	VDR is connected to JRC RMS.	-

(Blank page)

Chapter 7 After-sale Services

7.1 When Requesting a Repair

If you suspect that this equipment fails, read “Chapter 6 Maintenance and Inspection” and take the action recommended thereof.

However, if this equipment will still be faulty, please stop using this equipment and contact your sales representative, our sales department, nearest branch office or sales office.

1. Repair during the warranty period

If a failure occurs in the course of using the product correctly according to the explanations and instructions in this manual, your sales representative or our company shall repair the product at no charge. However, repairs of failures caused by misuse, negligence, or force majeure such as naturally disasters and fires shall make a charge for the repair.

2. If the warranty period has expired

If functionality can be recovered by the repair, the repair shall be made by request of the customer for a fee.

3. Please provide the following information

- 1) Product name
- 2) Product model
- 3) Serial number
- 4) Manufacturing date
- 5) Details of the problem (As much detail as possible. Please refer to the “VDR Failure Checklist” of the next page.)
- 6) Name of shipping company/organization
- 7) Ship name
- 8) Address
- 9) Telephone number
- 10) Fax number

If you have questions regarding after-sale services, please contact your sales representative, our sales department, nearest branch office or sales office.

VDR Failure Checklist

[IMPORTANT]

If ordering a repair, please check and fill in the following items. And then contact the applicable repair office. If there are unknown items, please contact the ship and fill in as accurately as possible.

Company name: _____	Equipment name: <u>VDR</u>
Ship name: _____	Model name: <u>JCY-1900</u>
Phone number: _____	Serial number: _____
FAX number: _____	Date of manufacture: _____

Check the following items sequentially and circle either “Yes” or “No” for each item. If neither applies or error code is displayed on the OPU, please write down details in (7).

Example:



(1)	The display of the OPU is off.	<input checked="" type="radio"/> Yes	<input type="radio"/> No
-----	--------------------------------	--------------------------------------	--------------------------

If item (1) or (2) is “Yes”, check the fuse of the RCU and the power distribution board of the ship.



No.	Check item	Result	
(1)	The display of the OPU is off.	Yes	No
(2)	The SYS LED on the MCB is off.	Yes	No
(3)	The SYS LED on the MCB is blinking.	Yes	No
(4)	The REC LED on the MCB is off.	Yes	No
(5)	The alert is displayed on the OPU.	Yes	No
(6)	The OPU is not operable.	Yes	No
(7)	Please write down all error codes that are displayed on the OPU.		
	Others		



7.2 About Disposal

7.2.1 About disposal of these equipment

 WARNING	
	If disposing of the recording control unit (NDV-1900), be sure to abide by applicable local laws and regulations.
	If disposing of the float-free capsule unit (NDH-339/NDH-339B), please contact our head office, or a nearby branch or local office to request servicing. There is a possibility that the emergency beacon is transmitted from disused satellite EPIRB when it is disposed improperly. If the emergency beacon is transmitted by improper disposal, large confusion is caused in search and rescue operations.

7.2.2 About disposal of the used batteries

 DANGER	
	The prohibited matter of a battery and a lithium battery. <ul style="list-style-type: none"> - To short-circuit the + pin and - pin - Using for non-specified applications - Disassembling, modifying, destroying - Throwing into fire, heating - Using expired battery There is a danger that causes leakage of fluid, generation of heat, fire, explosion, destruction, or injury by heat.

 WARNING	
	The recording control unit (NDV-1900) has a built-in battery. Do not discard because used batteries are recycled. Please contact our head office, or a nearby branch or local office to request servicing.
	The underwater acoustic beacon of fixed protective capsule unit and float-free capsule unit has a built-in lithium battery. Do not discard because used lithium batteries are recycled. Please contact our head office, or a nearby branch or local office to request servicing.

7.2.3 About the China RoHS

有毒有害物质或元素的名称及含量

(Names & Content of Toxic and Hazardous Substances or Elements)

形式名(Type): JCY-1900

名称(Name): Voyage Data Recorder

部件名称 (Part name)	有毒有害物质或元素 (Toxic and Hazardous Substances and Elements)					
	铅 (Pb)	汞 (Hg)	镉 (Cd)	六价铬 (Cr ⁶⁺)	多溴联苯 (PBB)	多溴二苯醚 (PBDE)
记录单元 (Recording Control Unit: NDV-1900) *: Except for CBN-80	○	○	○	○	○	○
操作单元 (Operation Panel Unit: NCG-1900)	○	○	○	○	○	○
固定式黑匣子 (Fixed Protective Capsule Unit: NDH-338)	×	○	○	○	○	○
自浮式黑匣子 (Float-Free Capsule Unit: NDH-339/339B)	○	○	○	○	○	○
接线盒 (Junction Box: NQA-7700A)	○	○	○	○	○	○
麦克风单元 (Microphone unit: NVT-181)	○	○	○	○	○	○
水密麦克风单元 (Waterproof microphone unit: NVT-182)	○	○	○	○	○	○
数字信号转换器 32路 (Digital Signal Converter 32ch: NCT-82)	○	○	○	○	○	○
数字信号转换器 64路 (Digital Signal Converter 64ch: NCT-83)	○	○	○	○	○	○
数据采集单元 (Data Acquisition Unit: NCT-84)	○	○	○	○	○	○
视频帧采集单元 (Frame Grabber Unit: NWP-69)	○	○	○	○	○	○
电池单元 (Battery Unit: CBN-80)	×	○	○	○	○	○
电线类 (Cables)	×	×	×	×	×	×
使用说明书 (Documents)	×	×	×	×	×	×

○ : 表示该有毒有害物质在该部件所有均质材料中的含量均在SJ/T11306-2006 标准规定的限量要求以下。
(Indicates that this toxic, or hazardous substance contained in all of the homogeneous materials for this part is below the requirement in SJ/T11363-2006.)

× : 表示该有毒有害物质至少在该部件的某一均质材料中的含量超出SJ/T11363-2006 标准规定的限量要求。
(Indicates that this toxic or hazardous substance contained in at least one of the homogeneous materials used for this part is above the limit requirement in SJ/T 11363-2006.)

Chapter 8 Specifications

8.1 NDH-338 Fixed Protective Capsule Unit

Performance

- | | |
|------------------------------------|--|
| a) Interface | |
| 1) Standard | IEEE802.3 (10Base-T/100Base-TX) |
| 2) Protocol | TCP/IP |
| b) Recording duration and capacity | |
| 1) Duration | 48 hours |
| 2) Capacity | 32GB |
| c) Data recording interval | |
| 1) Sensor data | Depends on the input from the sensors (usually 1 second) |
| 2) Audio data | Continuous (1 audio file per minute) |
| 3) Image data | 1 image file of each equipment per 15 seconds (X-Band Radar, S-Band Radar, Main-ECDIS and Sub-ECDIS) |
| d) Acoustic underwater beacon | |
| 1) Operating frequency | 37.5kHz \pm 1kHz |
| 2) Operating time | Min. 90 days after being immersed in the water |
| 3) Detectable range | 1,800m to 3,600m
Depends on surrounding environment (e.g. sea state, nearby boats, marine animals or other factors) |
| 4) Battery life expectancy | 3 years after manufacturing
Please note that lifetime may be shorter depending on environmental condition |
| 5) Battery specifications | Lithium battery (Li-SOCl ₂)
DC +3.6V 8.5Ah |
| e) Compass safety distance | |
| 1) Standard | 0.45m |
| 2) Steering | 0.45m |

Environmental condition

The recording data in the final recording medium shall be held without loss under below the condition.

a) Shock	A half sine-wave pulse of 50G, with a duration of 11 msec
b) Penetration	A mass of 250kg with a pin of 100mm diameter, dropped from 3m
c) Fire	10 hours with 260°C fire 1 hour with 1100°C fire
d) Deep-sea pressure and immersion	Immersion in sea water at pressure of 60MPa (equivalent to a depth of 6000m)

Environmental condition

a) Operating temperature	-25°C to +55°C (IEC60945 exposed type)
b) Storage temperature	-55°C to +70°C (IEC60945 exposed type)
c) Vibration	2Hz to 13.2Hz ±1.0mm 13.2Hz to 100Hz 0.7G

General specification

a) Input voltage range	DC +19.5 to +36.5V
b) Power consumption	5W
c) Size	185(w) x 252(d) x 275(h) mm
d) Mass	6.8kg
e) Color	Orange

8.2 NDH-339/NDH-339B Float-free Capsule Unit

8.2.1 NDH-339B In case of Float-free capsule complying with MSC.494(104)

Performance

a) Interface	
1) Standard	IEEE802.3 (10Base-T/100Base-TX)
2) Protocol	TCP/IP
b) Recording duration and capacity	
1) Duration	48 hours
2) Capacity	80GB
c) Data recording interval	
1) Sensor data	Depends on the input from the sensors (usually 1 second)
2) Audio data	Continuous (1 audio file per minute)
3) Image data	1 image file of each equipment per 15 seconds (X-Band Radar, S-Band Radar, Main-ECDIS and Sub-ECDIS)
d) EPIRB class	Class 2
e) Locator light	Flashing LED
f) Transmitter operation	
1) Operating time	168 hours
2) Battery expiration date	Replace at SBM 5 years after installing, 4 years depending on flag state. Please note that lifetime may be shorter depending on environmental condition.
3) Battery specifications	Lithium battery DC +7.2V 18Ah
g) 406MHz transmitter	
1) Frequency	406.031MHz \pm 2ppm
2) Output power	5W \pm 2dB
h) 121.5MHz transmitter	
1) Frequency	121.5MHz
2) Output power	Less than 100mW
i) AIS transmitter	
1) Frequency	161.975MHz \pm 1kHz (AIS 1) 162.025MHz \pm 1kHz (AIS 2)
2) Output power	1W
j) Hydrostatic release mechanism	
1) Operating depth	2m to 4m
2) Expiration date	2 years after installing
k) Lanyard (mooring rope)	
1) Length	Higher than 5m
2) Breaking strength	Higher than 25kg

- l) Compass safety distance
 - 1) Standard 0.8m
 - 2) Steering 0.6m

Environmental condition

- a) Degree of protection 10m depth at 5 minutes
- b) Operating temperature -20°C to +55°C (IEC61097-2 satellite EPIRB)
- c) Storage temperature -30°C to +70°C (IEC61097-2 satellite EPIRB)

General specification

- a) Input voltage range Power over Ethernet (IEEE802.3af)
- b) Power consumption 15W
- c) Size 237(w) x 214(d) x 534(h) mm
- d) Mass 5.4kg (including the EPIRB, bracket and cable)
- e) Color Orange

8.2.2 NDH-339 In case of Float-free capsule before complying with MSC.494(104)

Performance

a) Interface	
1) Standard	IEEE802.3 (10Base-T/100Base-TX)
2) Protocol	TCP/IP
b) Recording duration and capacity	
1) Duration	48 hours
2) Capacity	64GB
c) Data recording interval	
1) Sensor data	Depends on the input from the sensors (usually 1 second)
2) Audio data	Continuous (1 audio file per minute)
3) Image data	1 image file of each equipment per 15 seconds (X-Band Radar, S-Band Radar, Main-ECDIS and Sub-ECDIS)
d) EPIRB class	Class 2
e) Locator light	Flashing LED
f) Transmitter operation	
1) Operating time	168 hours
2) Battery expiration date	Replace at SBM 5 years after installing, 4 years depending on flag state. Please note that lifetime may be shorter depending on environmental condition.
3) Battery specifications	Lithium battery DC +7.2V 18Ah
g) 406MHz transmitter	
1) Frequency	406.037MHz \pm 2ppm
2) Output power	5W \pm 2dB
h) 121.5MHz transmitter	
1) Frequency	121.5MHz
2) Output power	Less than 100mW
i) Hydrostatic release mechanism	
1) Operating depth	2m to 4m
2) Expiration date	2 years after installing
j) Lanyard (mooring rope)	
1) Length	Higher than 5m
2) Breaking strength	Higher than 25kg
k) Compass safety distance	
1) Standard	0.8m
2) Steering	0.8m

Environmental condition

- | | |
|--------------------------|---|
| a) Degree of protection | 10m depth at 5 minutes |
| b) Operating temperature | -20°C to +55°C (IEC61097-2 satellite EPIRB) |
| c) Storage temperature | -30°C to +70°C (IEC61097-2 satellite EPIRB) |

General specification

- | | |
|------------------------|--|
| a) Input voltage range | Power over Ethernet (IEEE802.3af) |
| b) Power consumption | 15W |
| c) Size | 235.8(w) x 214.2(d) x 528.5(h) mm |
| d) Mass | 5.2kg (including the EPIRB, bracket and cable) |
| e) Color | Orange |

8.3 NDV-1900 Recording Control Unit

Performance

- | | | |
|----|--|---|
| a) | Interface to the fixed protective capsule unit | |
| 1) | Standard | IEEE802.3 (10Base-T/100Base-TX) |
| 2) | Protocol | TCP/IP |
| 3) | Power supply | Supply from the RCU |
| b) | Interface to the float-free capsule unit | |
| 1) | Standard | IEEE802.3 (10Base-T/100Base-TX) |
| 2) | Protocol | TCP/IP |
| 3) | Power supply | Supply from the RCU
Power over Ethernet (IEEE802.3af) |
| c) | Sensor data input | |
| 1) | Standard | IEC61162-1/-2/-450 |
| 2) | Input channel | Up to 48 channels
IEC61162-2: up to 2 channels
IEC61162-1: up to 22 channels
IEC61162-450: up to 24 channels (sensor sources on the network) |
| 3) | Recording interval | Depends on the input from the sensors (usually 1 second) |
| d) | Bridge audio input | |
| 1) | Interface | Audio signal (microphone unit output) |
| 2) | Input channel | Up to 12 channels
6 tracks, 1 track is synthesized from 2 channels |
| 3) | Recording interval | Continuous (1 audio file per minute) |
| 4) | Frequency response | 150Hz to 6kHz |
| e) | VHF communications audio input | |
| 1) | Interface | 0 dBm, 600-ohm balance |
| 2) | Input channel | Up to 4 channels
2 tracks, 1 track is synthesized from 2 channels |
| 3) | Recording interval | Continuous (1 audio file per minute) |
| 4) | Frequency response | 150Hz to 3.5kHz |

Performance (continued)

-
- | | |
|---|--|
| f) Image data input | |
| 1) Standard | IEC61162-450 |
| 2) Input channel | Up to 6 channels (image sources on the network) |
| 3) Recording interval | 1 image file of each equipment per 15 seconds
(X-Band Radar, S-Band Radar, Main-ECDIS and Sub-ECDIS)

* Recording image of each equipment is selected automatically |
| 4) Image format | PNG format

* Average image size: 512KB or less |
| g) Internal medium | |
| 1) Duration | 720 hours |
| 2) Capacity | 512GB |
| 3) Medium | Solid State Drive |
| h) Blackout processing | |
| 1) Recording duration | 2 hours while blackout (only bridge conversation) |
| 2) Restoration time required | Less than 1 minute (recovery time from blackout operation to normal operation on restoration of power supply) |
| 3) Battery specifications | Lead-acid battery
DC +12V 24Ah |
| 4) Battery life expectancy | 4 and a half years after manufacturing (ambient temperature: 25°C, load: 70%)

Please note that lifetime may be shorter depending on environmental condition |
| i) Connecting to the operating panel unit | |
| 1) Standard | IEEE802.3 (10Base-T/100Base-TX) |
| 2) Protocol | TCP/IP |
| 3) Power supply | DC +24V ±5% |
| j) Bridge alert management | |
| 1) Standard | IEC62923-1/-2 |
| 2) Interface | IEC61162-450

Physical: up to 4 ports
Logical: 1 channel |
| 3) Operation | BAM compliant equipment (alert source) |
| 4) Output sentence | IEC61162-1

ALC sentence - Cyclic alert list
ALF sentence - Alert sentence
ARC sentence - Alert command refused |
| 5) Input sentence | IEC61162-1

ACN sentence - Alert command |
-

Performance (continued)

- | | |
|-------------------------------|--|
| k) External alarm lamp output | |
| 1) Interface | Dry contact |
| 2) Operation | System down (Normal Close / Normal Open) |
| 3) Current | 1A or less at DC +24V
0.5A or less at AC 125V |
| l) GPS select signal input | |
| 1) Interface | Dry contact (also serve for external contact input) |
| 2) Operation | Recording GPS selection (Active Open / Active Close) |
| m) Compass safety distance | |
| 1) Standard | 0.9m |
| 2) Steering | 0.5m |

Environmental condition

- | | |
|-----------------------------|--|
| a) Operating temperature | -15°C to +55°C (IEC60945 protected type) |
| b) Temperature and humidity | +40°C, 93% (without dew condensation) |
| c) Vibration | 2Hz to 13.2Hz ±1.0mm
13.2Hz to 100Hz 0.7G |
| d) Protection class | IP22 |

General specification

- | | |
|--|--|
| a) Power voltage | AC 100 to 120V ±10%, 1-phase 50/60Hz (IEC60945)
AC 200 to 240V ±10%, 1-phase 50/60Hz (IEC60945) |
| b) Power consumption
(Including the fixed protective capsule unit, and the float-free capsule unit, the operation panel unit, and microphone) | 230W (In UPS battery charge)
70W (In normal operation) |
| c) Size | 419.5(w) x 214.0(d) x 480.5(h) mm |
| d) Mass | 22.5kg |
| e) Color | N2.5 semi-gloss texture |

8.4 NCG-1900 Operation Panel Unit

Performance

a) Mounting	Flush mount type
b) Interface to the RCU	
1) Standard	IEEE802.3 (10Base-T/100Base-TX)
2) Protocol	TCP/IP
3) Power supply	Supply from the RCU
c) Indication	7-inch wide color LCD (800 x 480 pixels) Speaker
d) Operation	Touch panel Rotary knob
e) USB connector	A type receptacle (for USB memory)
f) Compass safety distance	
1) Standard	0.5m
2) Steering	0.3m
g) Viewing distance	1m

Environmental condition

a) Operating temperature	-15°C to +55°C (IEC60945 protected type)
b) Temperature and humidity	+40°C, 93% (without dew condensation)
c) Vibration	2Hz to 13.2Hz ±1.0mm 13.2Hz to 100Hz 0.7G
d) Protection class	IP22

General specification

a) Power voltage	DC +24V ±5%
b) Size	225(w) x 37.5(d) x 136(h) mm (without projection)
c) Mass	0.8kg
d) Color	N2.5 semi-gloss

8.5 NVT-181 Microphone Unit

Performance

a) Mounting	Ceiling mount type
b) Device	Electret condenser microphone
c) Directivity	Hemisphere indirectivity
d) Range of receive	Radius of 3.5m
e) Power supply	Supply from the RCU
f) Microphone test	Built-in speaker for self-diagnosis test
g) Compass safety distance	
1) Standard	0.1m
2) Steering	0.1m

Environmental condition

a) Operating temperature	-15°C to +55°C (IEC60945 protected type)
b) Temperature and humidity	+40°C, 93% (without dew condensation)
c) Vibration	2Hz to 13.2Hz ±1.0mm 13.2Hz to 100Hz 0.7G
d) Protection class	IP22

General specification

a) Size	110(w) x 51(d) x 110(h) mm
b) Mass	0.2kg
c) Color	N2.5

8.6 NVT-182 Waterproof Microphone Unit

Performance

a) Mounting	Wall mount type
b) Device	Electret condenser microphone
c) Directivity	Hemisphere indirectivity
d) Range of receive	Radius of 3.5m
e) Power supply	Supply from the RCU
f) Microphone test	Built-in speaker for self-diagnosis test
g) Compass safety distance	
1) Standard	0.1m
2) Steering	0.1m

Environmental condition

a) Operating temperature	-25°C to +55°C (IEC60945 exposed type)
b) Temperature and humidity	+40°C, 93% (without dew condensation)
c) Vibration	2Hz to 13.2Hz ±1.0mm 13.2Hz to 100Hz 0.7G
d) Protection class	IP56

General specification

a) Size	126(w) x 86(d) x 111(h) mm
b) Mass	0.5kg
c) Color	N7

8.7 NCT-83 Digital Signal Converter (64CH)

Performance

a) Dry contact input	Dry contact
b) Dry contact input channel	Up to 64 channels
c) Contact closure interface	
1) Driving power supply	DC +12V
2) Logic	Normal Close / Normal Open
d) Communication port	Connect to the RCU
e) Output sentence	IEC61162-1
f) Compass safety distance	
1) Standard	0.4m
2) Steering	0.2m

Analog Interface (option)

If the optional analog to digital conversion board CEF-60 is added.

a) Analog signal input channel	Up to 8 channels
b) Analog signal interface	
1) Voltage range	±1V, ±5V, ±10V
2) Current range	±20mA
c) Communication port	Connect to the RCU (same port as dry contact signals)
d) Output sentence	IEC61162-1 XDR sentence - Transducer measurement

Environmental condition

a) Operating temperature	-15°C to +55°C (IEC60945 protected type)
b) Temperature and humidity	+40°C, 93% (without dew condensation)
c) Vibration	2Hz to 13.2Hz ±1.0mm 13.2Hz to 100Hz 0.7G
d) Protection class	IP22

General specification

a) Power voltage	AC 100 to 120V ±10%, 1-phase 50/60Hz (IEC60945) AC 200 to 240V ±10%, 1-phase 50/60Hz (IEC60945)
b) Power consumption	25VA
c) Size	300(w) x 130(d) x 420(h) mm
d) Mass	4.2kg
e) Color	N2.5 semi-gloss

8.8 NCT-82 Digital Signal Converter (32CH)

Performance

a) Dry contact input	Dry contact
b) Dry contact input channel	Up to 32 channels
c) Contact closure interface	
1) Driving power supply	DC +12V
2) Logic	Normal Close / Normal open
d) Communication port	Connect to the RCU
e) Output sentence	IEC61162-1
f) Compass safety distance	
1) Standard	0.3m
2) Steering	0.2m

Analog interface (option)

If the optional analog to digital conversion board CEF-60 is added.

a) Analog signal Input channel	Up to 8 channels
b) Analog signal interface	
1) Voltage range	±1V, ±5V, ±10V
2) Current range	±20mA
c) Communication port	Connect to the RCU (same port as dry contact signals)
d) Output sentence	IEC61162-1 XDR sentence - Transducer measurement

Environmental condition

a) Operating temperature	-15°C to +55°C (IEC60945 protected type)
b) Temperature and humidity	+40°C, 93% (without dew condensation)
c) Vibration	2Hz to 13.2Hz ±1.0mm 13.2Hz to 100Hz 0.7G
d) Protection class	IP22

General specification

a) Power voltage	AC 100 to 120V ±10%, 1-phase 50/60Hz (IEC60945) AC 200 to 240V ±10%, 1-phase 50/60Hz (IEC60945)
b) Power consumption	20VA
c) Size	300(w) x 130(d) x 230(h) mm
d) Mass	2.8kg
e) Color	N2.5 semi-gloss

8.9 NWP-69 Frame Grabber Unit

Performance

a) Image data input	
1) Input channel	2 channels
2) Input interface	Analog RGB / Hs / Vs
- RGB	0.7Vp-p (video signal)
- Hs	TTL
- Vs	TTL
3) Resolution	640 x 350 to 1600 x 1200 pixel (according to VESA DMTS)
	1920 x 1200 pixel (according to VESA CVT RB)
4) Refresh rate	60 to 85 Hz (according to VESA DMTS)
	(Resolution 1600 x 1200 pixel, 1920 x 1200 pixel 60Hz only)
5) Recording interval	1 image every 15 seconds (each channel)
b) Communication port	Connect to the RCU via ethernet
c) Compass safety distance	
1) Standard	0.6m
2) Steering	0.3m

Environmental condition

a) Operating temperature:	-15°C to +55°C (IEC60945 protected type)
b) Temperature and humidity:	+40°C, 93% (without dew condensation)
c) Vibration:	2Hz to 13.2Hz ±1.0mm
	13.2Hz to 100Hz 0.7G
d) Protection class	IP22

General specification

a) Power voltage	AC 100 to 120V ±10%, 1-phase 50/60Hz (IEC60945)
	AC 200 to 240V ±10%, 1-phase 50/60Hz (IEC60945)
b) Power consumption	15VA
c) Size	255(w) x 248(d) x 72(h) mm
d) Mass	1.5kg
e) Color	N2.5 semi-gloss

8.10 NCT-84 Data Acquisition Unit

Performance

- | | |
|----------------------------|---------------------------------|
| a) Input sensor channel | |
| 1) IEC61162-1 | 8 channels |
| 2) IEC61162-2 | 2 channels |
| b) Interface to the RCU | |
| 1) Standard | IEEE802.3 (10Base-T/100Base-TX) |
| 2) Protocol | TCP/IP |
| c) Compass safety distance | |
| 1) Standard | 0.9m |
| 2) Steering | 0.5m |

Gyro interface

- | | |
|--------------------|--|
| a) Signal input | - Synchronized signal for the gyro compass
Ratio: 360X / 180X / 90X / 36X
Voltage: AC +24 to +115V
Frequency: 50 / 60 / 400Hz |
| | - Step signal for the gyro compass
Ratio: 360X / 180X / 90X / 36X
Voltage: DC +21.6 to +70V |
| | - Pulse signal for the speed log
Ratio: 800P / 400P / 200P / 100P
Voltage: DC 0 to +50V (threshold 2V) |
| b) Output sentence | IEC61162-1
THS sentence - True heading and status
VBW sentence - Dual ground/water speed |

Environmental condition

- | | |
|-----------------------------|--|
| a) Operating temperature | -15°C to +55°C (IEC60945 protected type) |
| b) Temperature and humidity | +40°C, 93% (without dew condensation) |
| c) Vibration | 2Hz to 13.2Hz ±1.0mm
13.2Hz to 100Hz 0.7G |
| d) Protection class | IP22 |

General specification

- | | |
|----------------------|--|
| a) Power voltage | AC 100 to 120V ±10%, 1-phase 50/60Hz (IEC60945)
AC 200 to 240V ±10%, 1-phase 50/60Hz (IEC60945) |
| b) Power consumption | 18VA |
| c) Size | 300(w) x 130(d) x 420(h) mm |
| d) Mass | 4.3kg |
| e) Color | N2.5 semi-gloss |

8.11 NQE-7700A Junction Box

Performance

- a) Interface Built-in terminal blocks

Environmental condition

- a) Operating temperature: -25°C to +55°C (IEC60945 protected type)
b) Temperature and humidity: +40°C, 93% (without dew condensation)
c) Vibration 2Hz to 13.2Hz ±1.0mm
13.2Hz to 100Hz 0.7G
d) Protection class IP56

General specification

- a) Size 120(w) x 139(d) x 78(h) mm
b) Mass 0.6kg
c) Color 7.5BG 7/2

8.12 General Environmental Condition

Operating condition and location

- | | |
|----------------------------------|--|
| a) Usage Conditions | |
| 1) Target vessels | - Mercantile vessels of 3000G/T or more that are engaged in international voyage
- Passenger vessels of 150G/T or more that are engaged in international voyage |
| b) Unit installation locations | |
| 1) Fixed protective capsule unit | External deck above bridge |
| 2) Float-free capsule unit | External deck above bridge |
| 3) Recording control unit | Bridge (or electronic room) |
| 4) Operation panel unit | Navigation space in a Bridge |
| 5) Microphone unit | Ceiling or bulkhead |
| 6) Waterproof microphone unit | Wings |
| 7) Digital signal converter | Bridge (or electronic room) |
| 8) Frame grabber unit | Near the radar/ECDIS |
| 9) Data acquisition unit | Bridge (or electronic room) |
| c) Installation methods | |
| 1) Fixed protective capsule unit | Mounted on the deck |
| 2) Float-free capsule unit | Hung on the deck |
| 3) Recording control unit | Hung on the bulkhead |
| 4) Operation panel unit | Hung on the bulkhead or flash mount on the console |
| 5) Microphone unit | Ceiling or bulkhead |
| 6) Waterproof microphone unit | Hung on the bulkhead |
| 7) Digital signal converter | Hung on the bulkhead |
| 8) Frame grabber unit | Mounted on the radar/ECDIS |
| 9) Data acquisition unit | Hung on the bulkhead |

Power supply environment

- | | |
|--------------------------------|--|
| a) AC power supply input range | AC 100/110/115/120V $\pm 10\%$
AC 200/220/240V $\pm 10\%$ |
| b) AC power supply frequency | 50Hz $\pm 5\%$ |
| fluctuation range | 60Hz $\pm 5\%$ |

Environment condition

a) Exposed type equipment

Fixed protective capsule unit, waterproof microphone unit

- 1) Operation temperature range -25°C to +55°C
- 2) Storage temperature -25°C to +70°C
- 3) Temperature and humidity +40°C, 93% (without dew condensation)
- 4) Vibration 2Hz to 13.2Hz ±1.0mm
 13.2Hz to 100Hz 0.7G

b) Protected type equipment

Recording control unit, Operation panel unit, microphone unit, option unit

- 1) Operation temperature range -15°C to +55°C
- 2) Temperature and humidity +40°C, 93% (without dew condensation)
- 3) Vibration 2Hz to 13.2Hz ±1.0mm
 13.2Hz to 100Hz 0.7G

c) Portable type equipment

Float-free capsule unit

- 1) Operation temperature range -20°C to +55°C
- 2) Storage temperature -30°C to +70°C
- 3) Temperature and humidity +40°C, 93% (without dew condensation)
- 4) Vibration 2Hz to 13.2Hz ±1.0mm
 13.2Hz to 100Hz 0.7G

8.13 Software license information

This equipment includes the software where the GNU General Public License (GPL) is applicable. Our customers who desire to do so can obtain, modify or redistribute the source code of the applicable software.

To obtain the source code, please contact us at the following e-mail address.

- E-mail address: tmsc@jrc.co.jp
- E-mail title: Request for source code based on the GPL
- Necessary information:
1. Product name
 2. Model number
 3. Serial number
 4. Customer's company name and office location
 5. Vessel name or IMO number
 6. Message text, for example as follows;
"Send us the source code of the target software of the Product mentioned above."

[NOTE]

Customer is responsible for the cost concerning providing the source code.

[NOTE]

The source code is WITHOUT ANY WARRANTY. And also, we cannot respond to any questions concerning the GPL source codes.

Chapter 9 Outside Drawings

9.1 NDH-338 Fixed Protective Capsule Unit

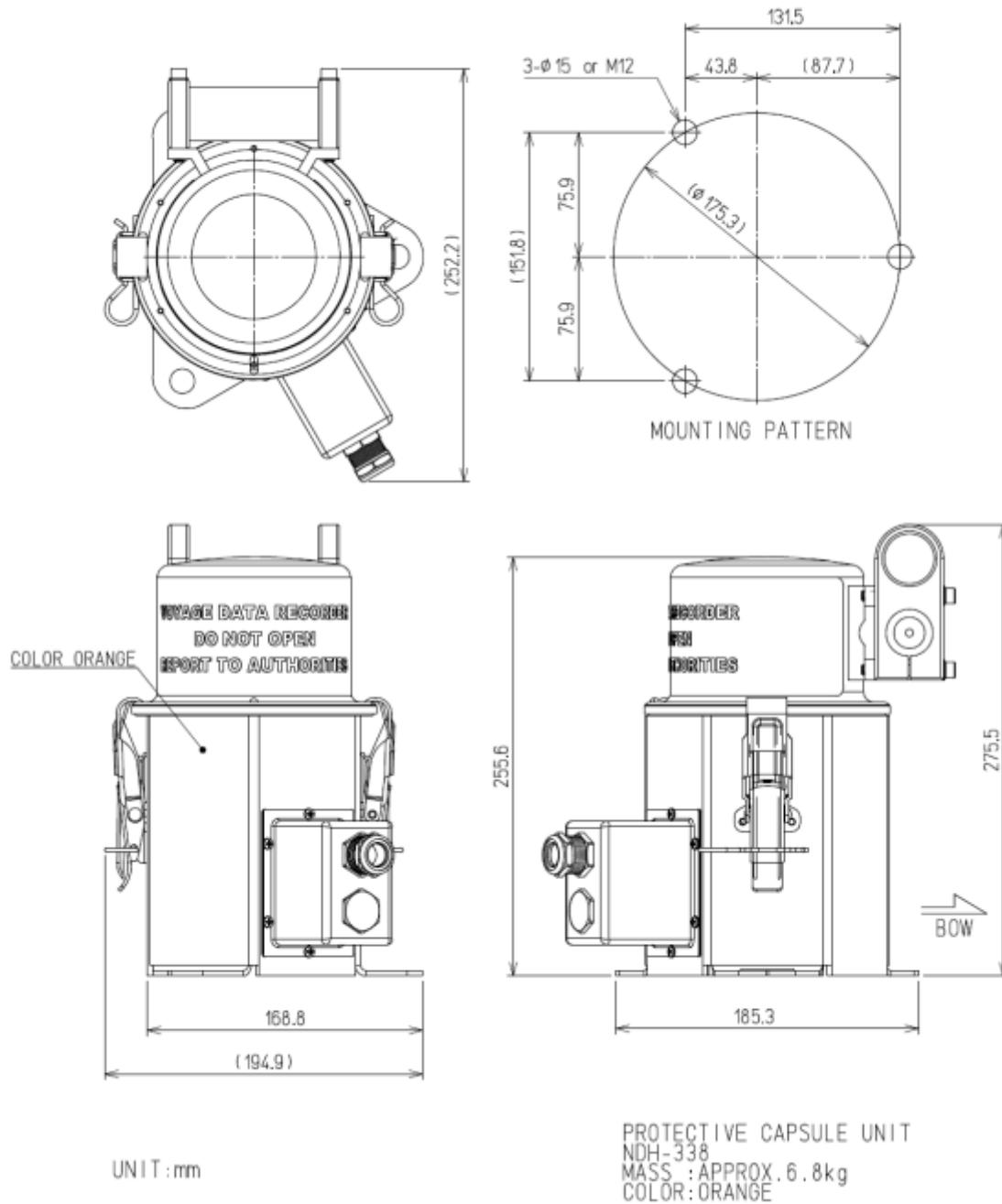

9.2 NDH-339/NDH-339B Float-free Capsule Unit

9.2.1 NDH-339B In case of Float-free capsule complying with MSC.494(101)

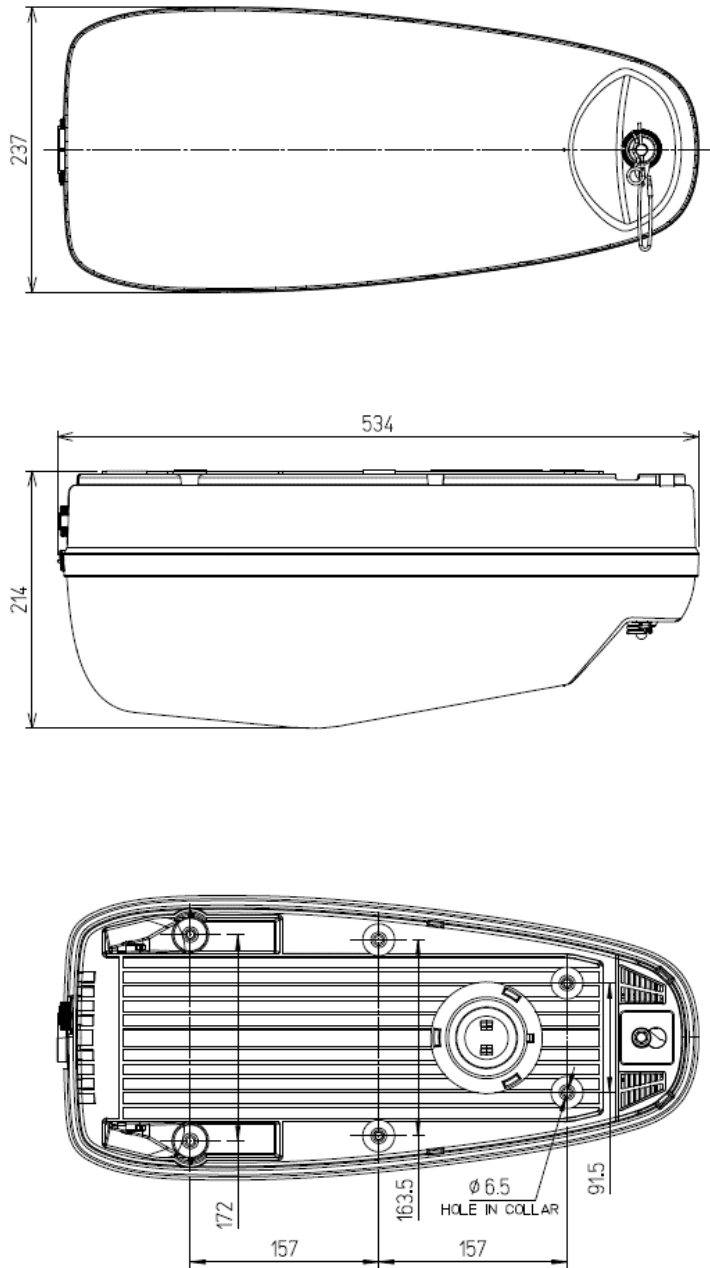

FLOAT-FREE CAPSULE UNIT
NDH-339B
MASS: APPROX. 5.4kg
COLOR: ORANGE

UNIT: mm

9.2.2 NDH-339 In case of Float-free capsule before complying with MSC.494(101)

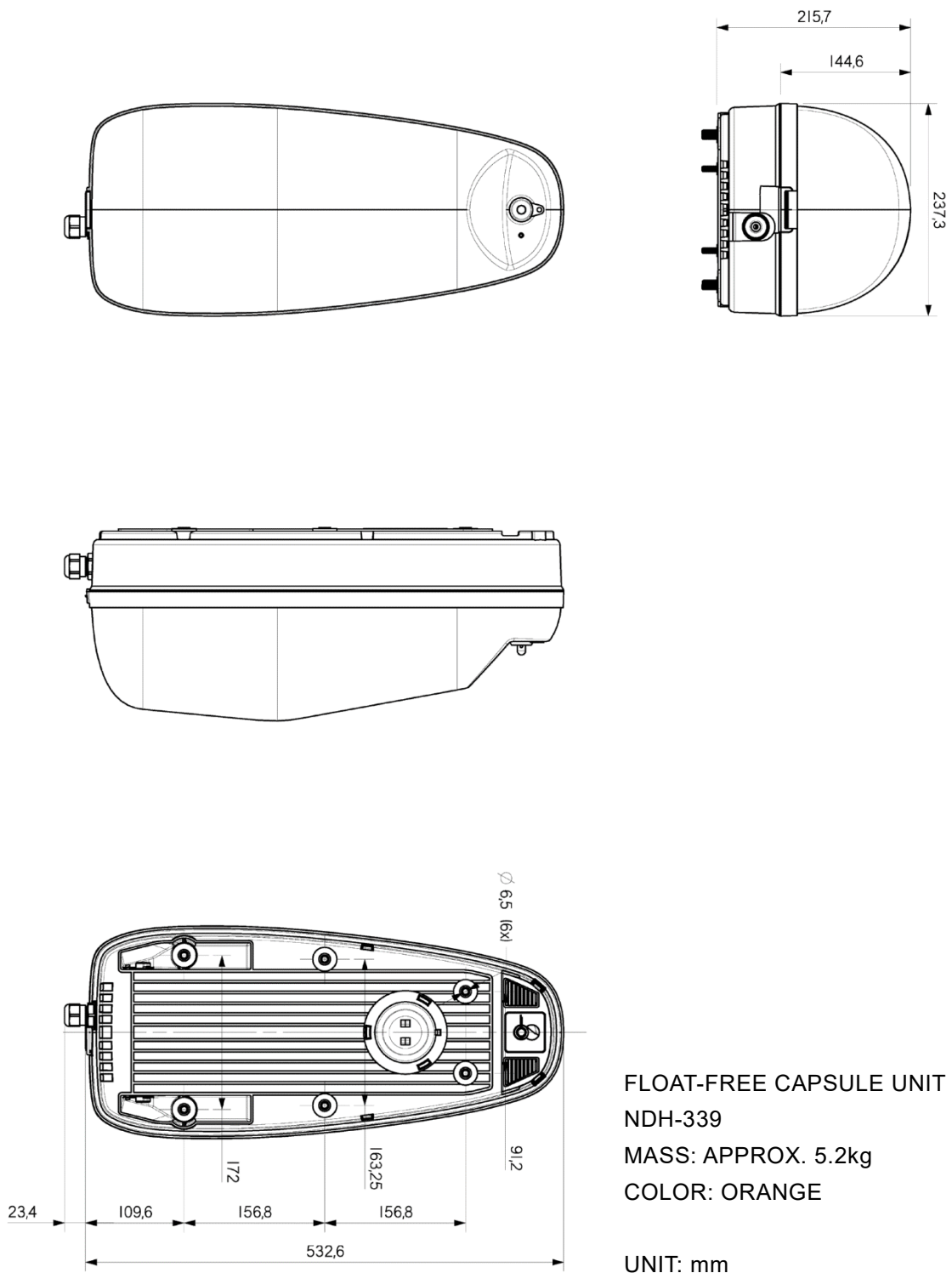

9.3 NDV-1900 Recording Control Unit

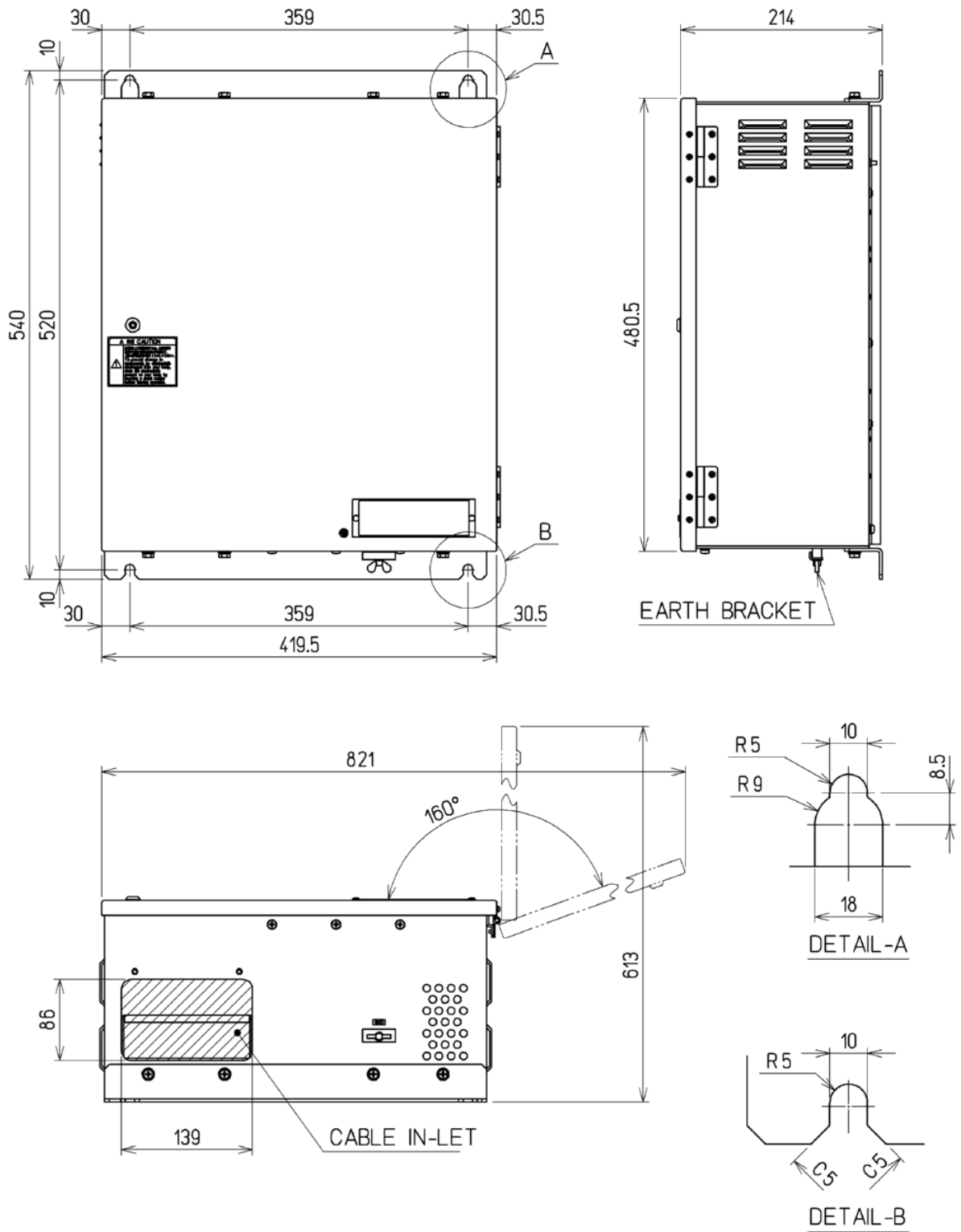

COLOR : N2.5 SEMI-GLOSS TEXTURE

MASS : APPROX. 22.5kg

UNIT: mm

9.4 NCG-1900 Operation Panel Unit

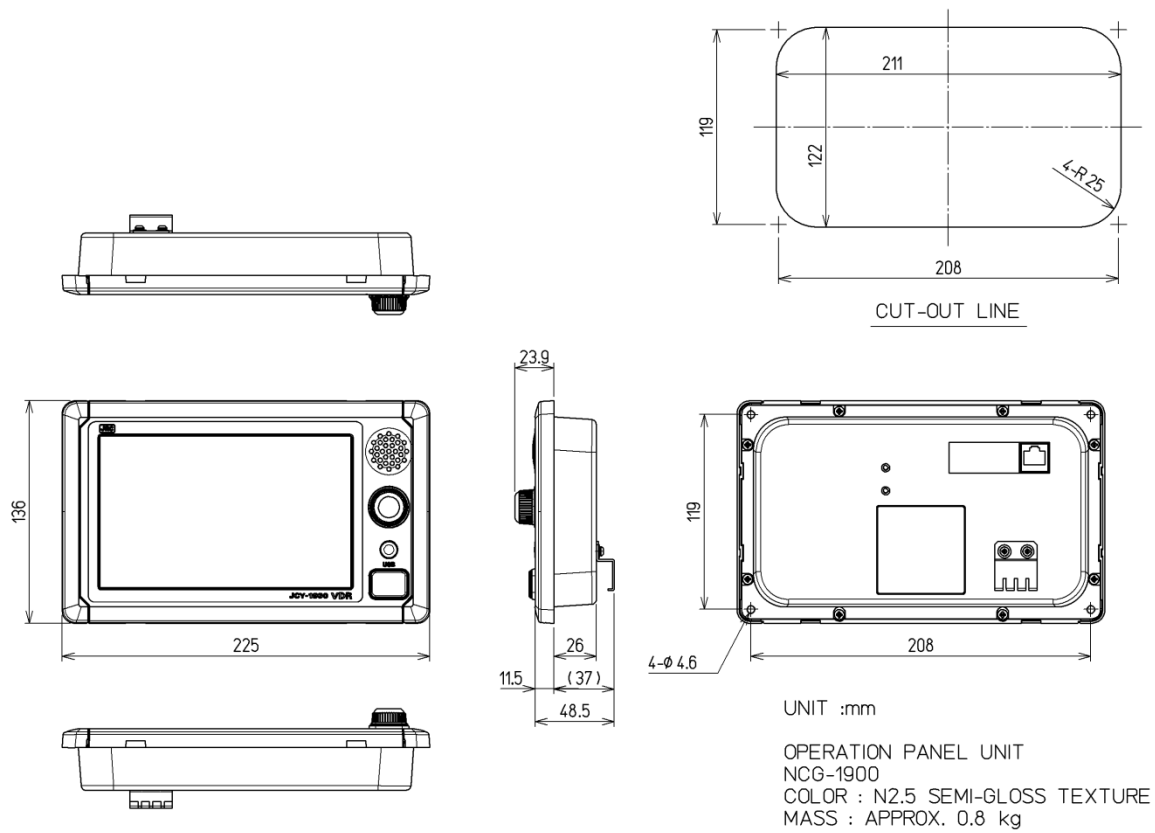

9.5 NVT-181 Microphone Unit

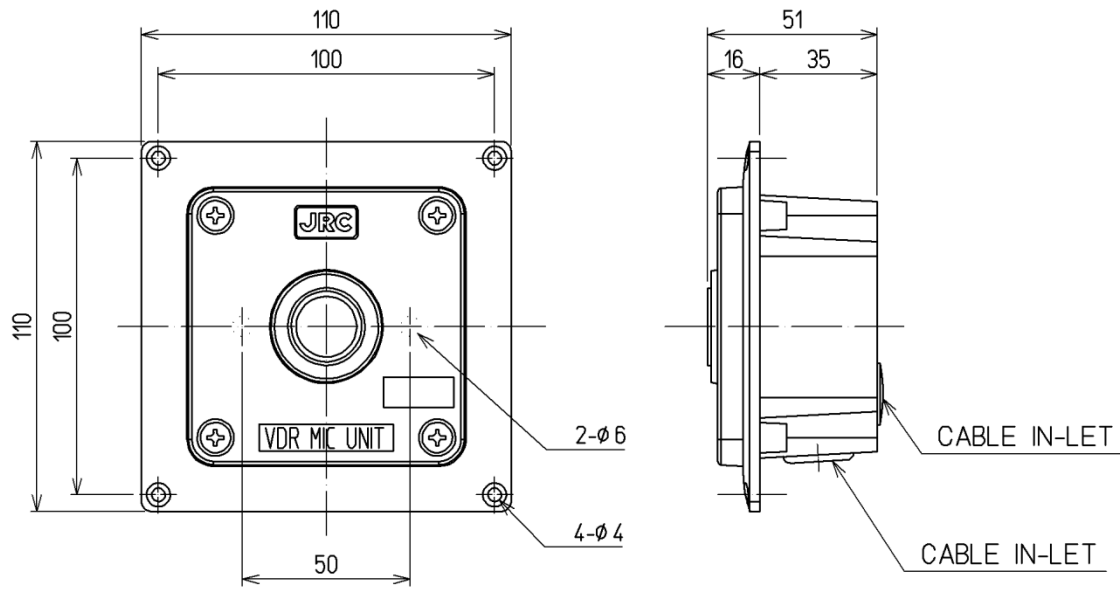

CUT-OUT LINE

UNIT : mm

MICROPHONE UNIT
NVT-181

COLOR : N2.5

MASS : APPROX. 0.2kg

In case of lot number YYMMxxxxB or later (Ver. B or later)

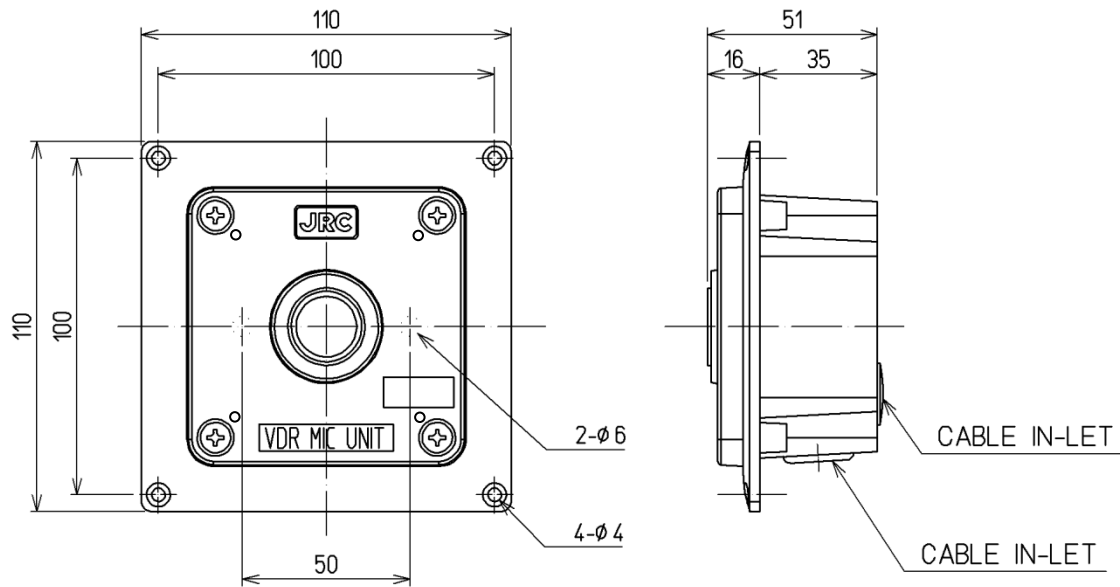

UNIT : mm

MICROPHONE UNIT
NVT-181

COLOR : N2.5

MASS : APPROX. 0.2kg

CUT-OUT LINE

9.6 NVT-182 Waterproof Microphone Unit

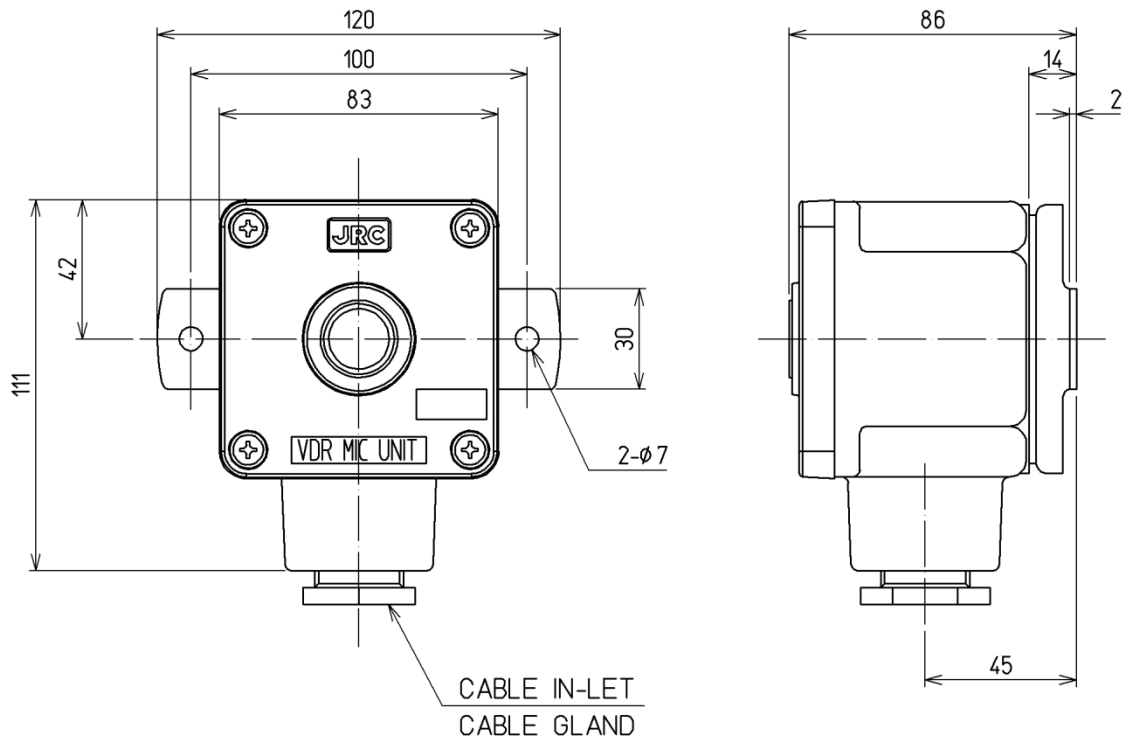

UNIT : mm

WATERPROOF MICROPHONE UNIT
NVT-182
COLOR : N7
MASS : APPROX. 0.5kg

In case of lot number YYMMxxxxA or later (Ver. A or later)

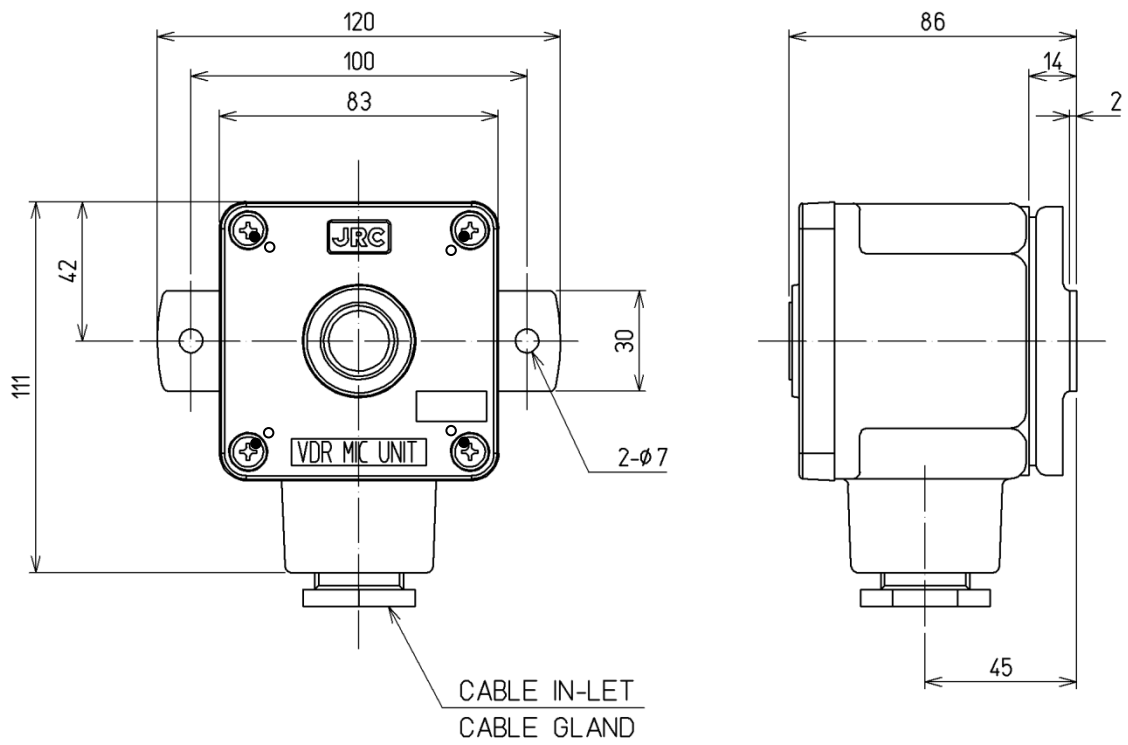

UNIT : mm

WATERPROOF MICROPHONE UNIT
NVT-182
COLOR : N7
MASS : APPROX. 0.5kg

9.7 NCT-83 Digital Signal Converter (64CH)

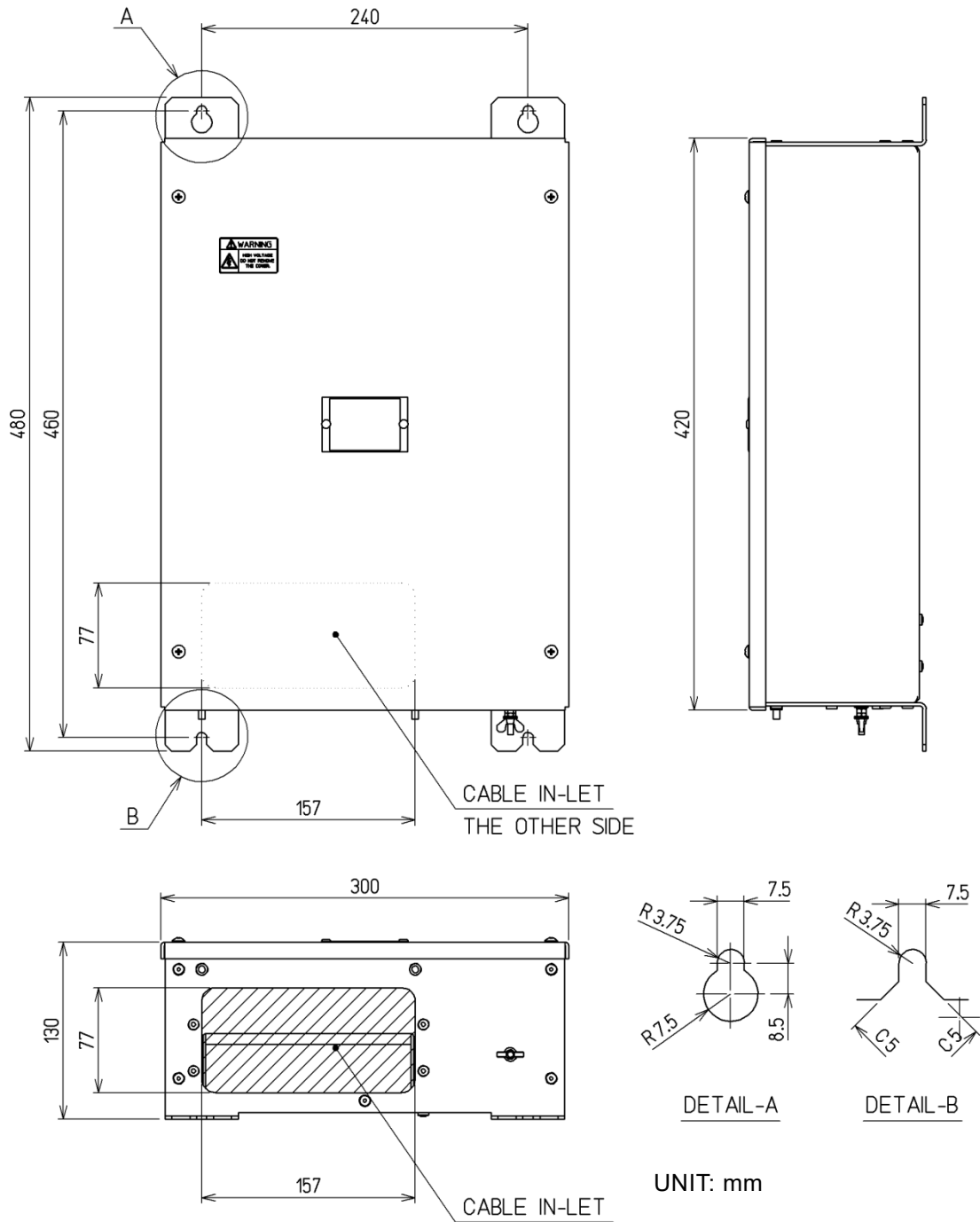

CABLE IN-LET
THE OTHER SIDE

CABLE IN-LET

DETAIL-A

DETAIL-B

UNIT: mm

DIGITAL SIGNAL CONVERTER
NCT-83
COLOR : N2.5 SEMI-GLOSS
MASS : APPROX. 4.2kg

9.8 NCT-82 Digital Signal Converter (32CH)

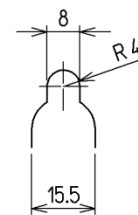
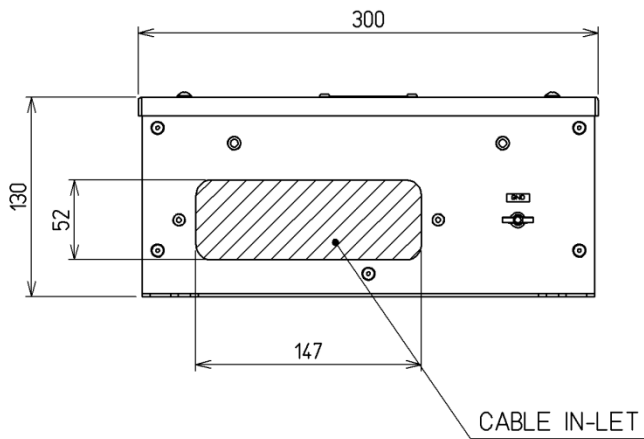
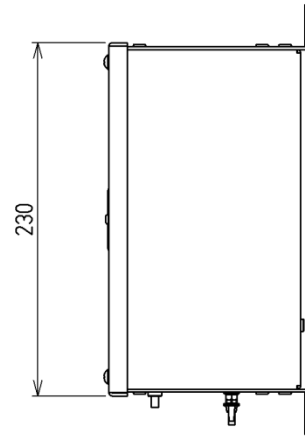
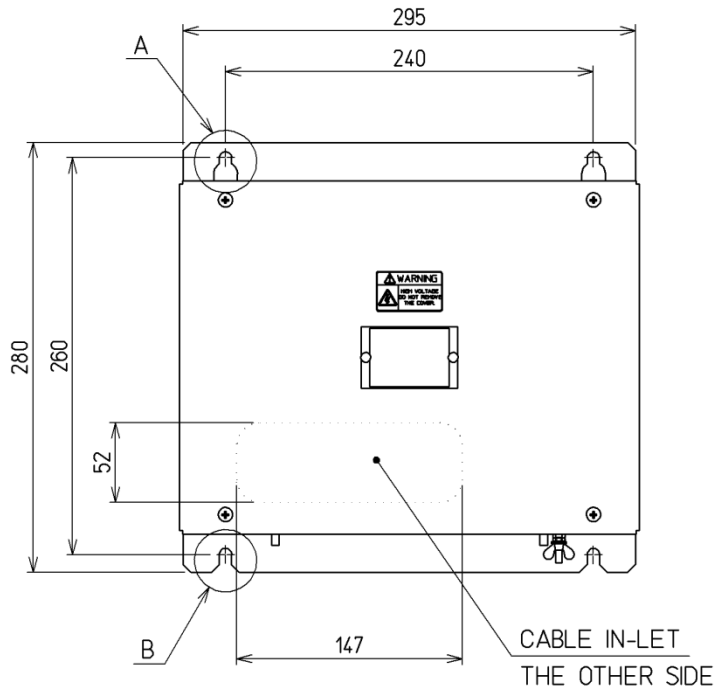

DETAIL-A

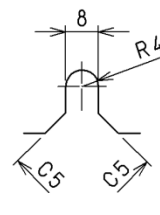

DETAIL-B

UNIT: mm

DIGITAL SIGNAL CONVERTER
 NCT-82
 COLOR : N2.5 SEMI-GLOSS
 MASS : APPROX. 2.8kg

9.9 NWP-69 Frame Grabber Unit

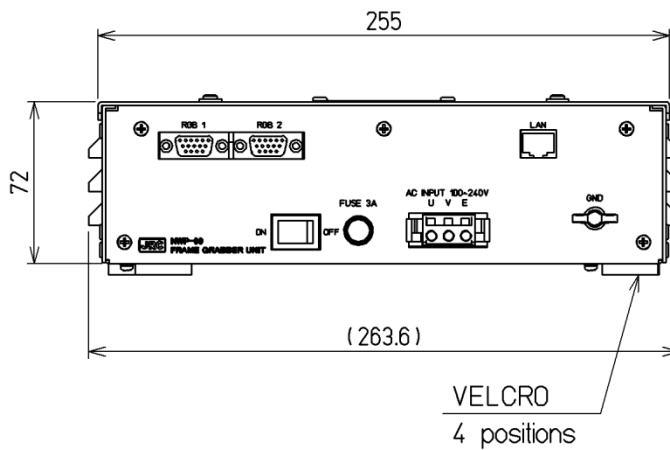
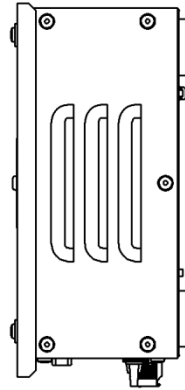
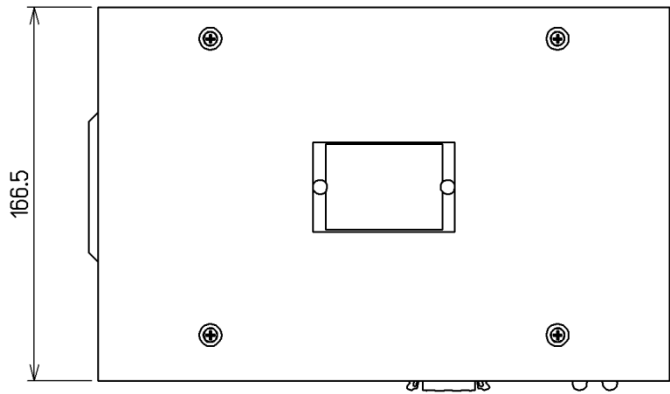

UNIT : mm

FRAME GRABBER UNIT
NWP-69
COLOR : N2.5 SEMI-GLOSS
MASS : APPROX. 1.5kg

Standard item (there is no waterproof hood)

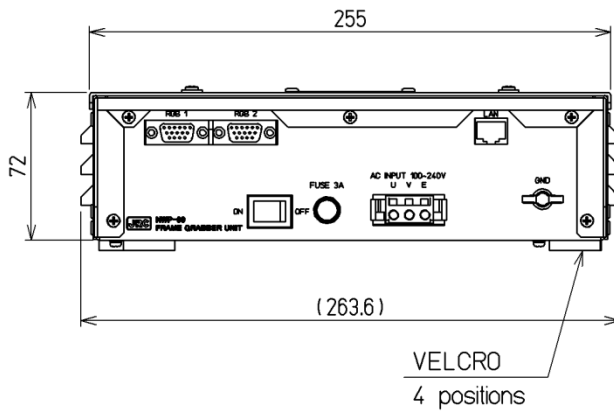
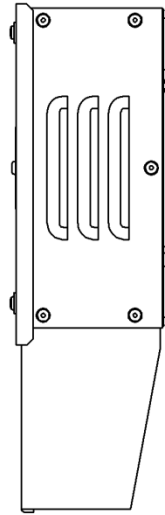
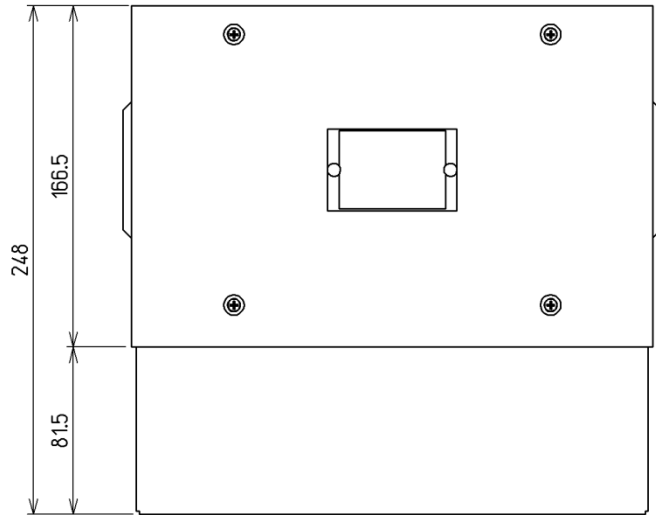

UNIT : mm

FRAME GRABBER UNIT
 NWP-69
 COLOR : N2.5 SEMI-GLOSS
 MASS : APPROX. 1.7kg

Option item (there is a waterproof hood)

9.10 NCT-84 Data Acquisition Unit

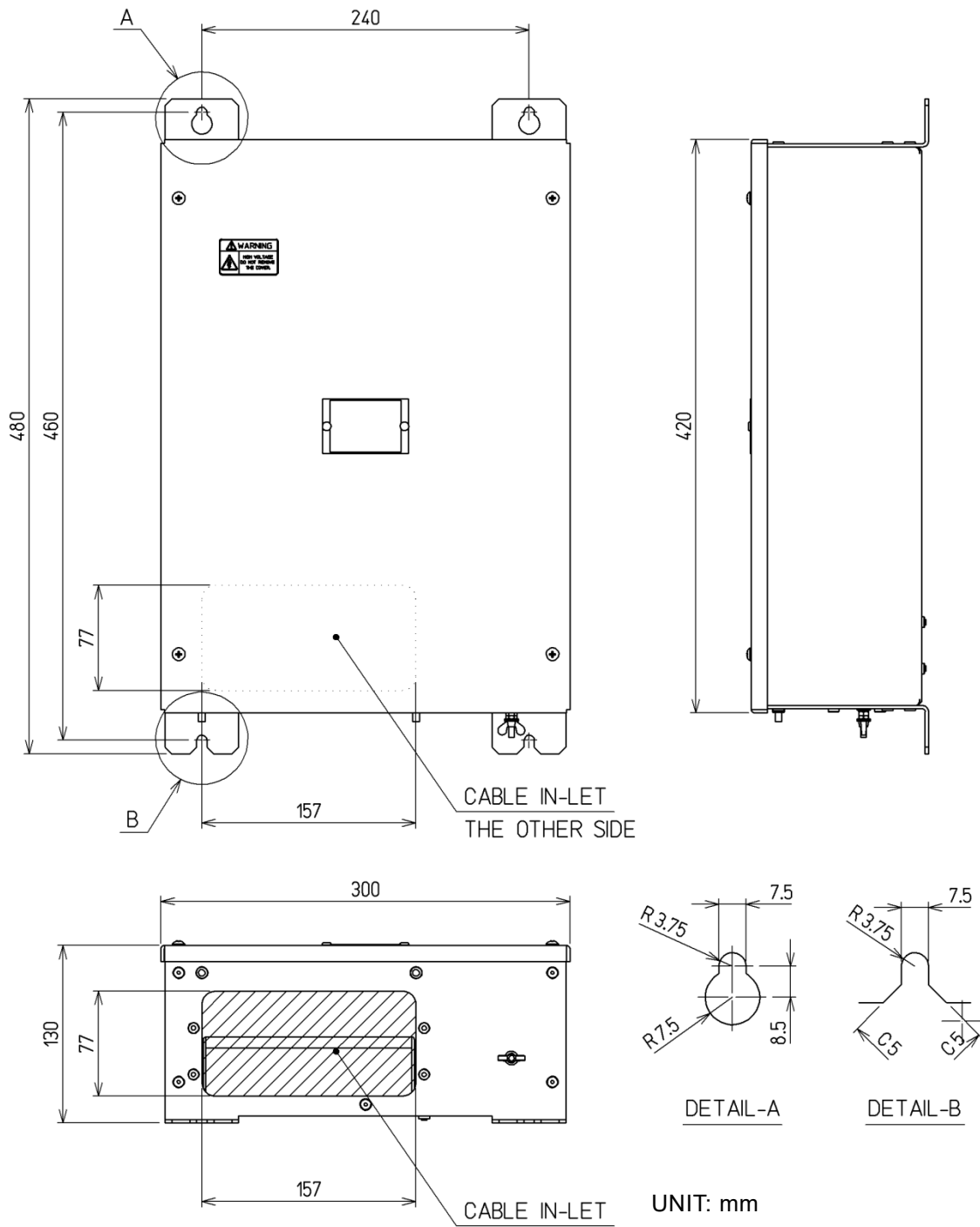

DATA ACQUISITION UNIT
 NCT-84
 COLOR : N2.5 SEMI-GLOSS
 MASS : APPROX. 4.3kg

9.11 NQE-7700A Junction Box

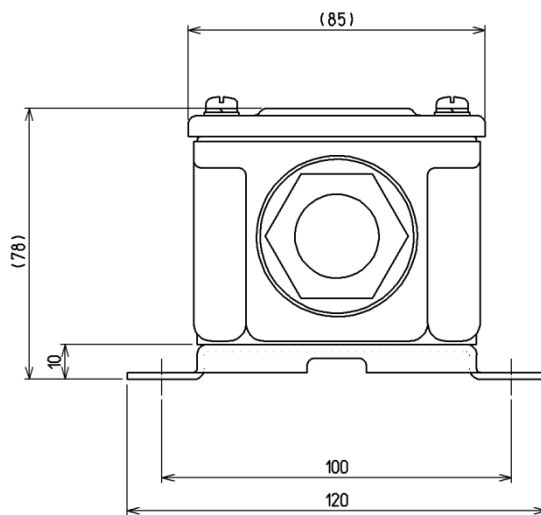
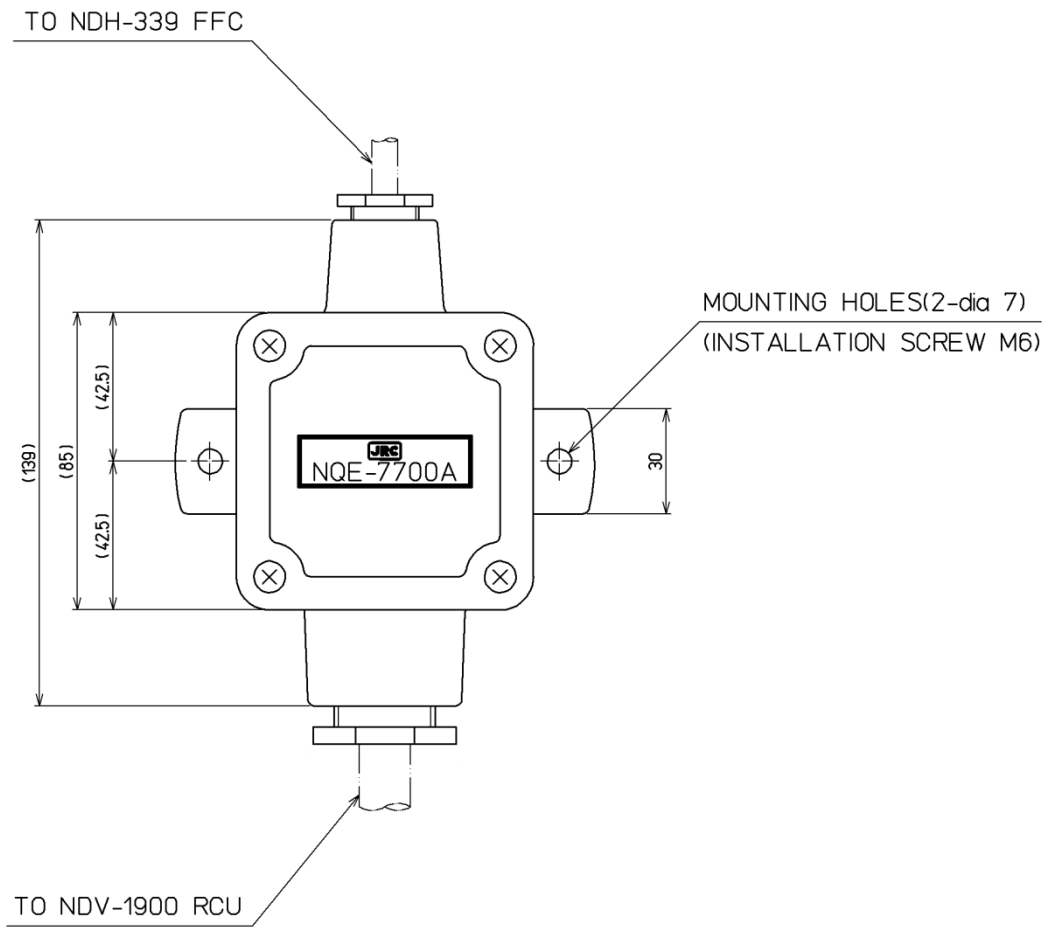

Unit : mm
 IP Grade : IP56
 MASS : 0.6kg

(Blank page)

アスベストは使用していません
Not use the asbestos

For further information, contact:

JRC *Japan Radio Co., Ltd.*

Since 1915

URL Head office : <http://www.jrc.co.jp/eng/>

Marine Service Department

1-7-32 Tatsumi, Koto-ku, Tokyo 135-0053, Japan

e-mail : tmsc@jrc.co.jp

One-call : +81-50-3786-9201

ISO 9001, ISO 14001 Certified

CODE No.7ZPNA4384K

JAN. 2025 Edition 11